**User's
Manual**

**Model US1000
Digital Indicating Controller**

IM 5D1A01-01E

Introduction

This instruction manual describes the general operation of the US1000 Digital Indicating Controller.

■ Intended Readers

This manual is intended for personnel in charge of the following:

- Installation and wiring
- Instrumentation and setup of the controller
- Operation and monitoring of the controller
- Maintenance of equipment

■ Related Documents

The following documents all relate to the US1000 Digital Indicating Controller. Read them as necessary. The codes enclosed in parentheses are the document numbers.

- US1000 Digital Indicating Controller Functions (IM 5D1A01-02E)
Provides detailed descriptions of US1000 functions.
- US1000 Digital Indicating Controller Communication Functions (IM 5D1A01-10E)
Manual for using the US1000 communication function. Supplied with models having the optional communication function.
- LL1100 PC-Based Parameters Setting Tool (IM 5G1A01-01E)
Manual for setting US1000 parameters from a personal computer. Supplied with the LL1100 PC-Based Parameters Setting Tool.
- LL1200 PC-based Custom Computation Building Tool (IM 5G1A11-01E)
Operation manual for creating custom computations of the US1000 controller. This manual also describes examples of custom computations. The LL1200 PC-based Custom Computation Building Tool includes the LL1100 PC-based Parameters Setting Tool.
- LL1200 PC-based Custom Computation Building Tool Reference (IM 5G1A11-02E)
This is the functions manual necessary for creating custom computations of the US1000 controller. This manual should be referred to in order to find out and understand what functions offered by the LL1200.

Checking Package Contents

Visually check the product for any damage upon delivery.

Keep the box and inner packaging that the product was delivered in, as you will need them if you have to send the controller back for repair.

■ Checking of Model and Suffix Codes

Check the model and suffix codes of the delivered controller to ensure that it is the right model.

Model	Suffix Codes	Option Codes	Description	Analog input		Analog output				Contact	
				Universal	Voltage	LPS	Current	Voltage	Relay	Input	Output
US1000	-00		Basic type	1	1	1	1	1	0	2	3
	-11		Enhanced type (with custom computation)	2	1	2	2	1	2	7	7
	-21		Position proportional type (with custom computation)	2	1	2	1	1	*2	7	7
		/A10	RS-485 communication								

LPS: Loop power supply for transmitter

* The two contact points in the US1000-21 relay item are the relay output and the feedback input.

■ Package Contents

Check the package contents against the list below. If anything is missing or damaged, immediately contact the dealer at which you purchased the product or your nearest Yokogawa representative.

- US1000 controller 1
- Brackets (Part No. T9115NK) 1 pair
- Terminal board cover (Part No. L4001DA) 1
- Unit label (Part No. T9115VE) 1

Instruction manuals

- US1000 Digital Indicating Controller (this manual) 1
- US1000 Digital Indicating Controller Functions 1
- US1000 Digital Indicating Controller Communication Functions 1
(Only supplied with models having the optional communication function.)

Documentation Conventions

■ Symbols

The following symbols are used in this manual.



WARNING

Indicates that operating the hardware or software in a particular manner may damage it or result in a system failure.



NOTE

Draws attention to information that is essential for understanding the operation and/or features of the product.



TIP

Gives additional information to complement the present topic and/or describe terms specific to this document.



See Also

Gives reference locations for further information on the topic.

■ Description of Displays

Some of the representations of product displays shown in this manual may be exaggerated, simplified, or partially omitted for reasons of convenience when explaining them.

Notice

■ This Instruction Manual

- (1) This manual should be passed on to the end user. Keep at least one extra copy of the manual in a safe place.
- (2) Read this manual carefully to gain a thorough understanding of how to operate this product before you start using it.
- (3) This manual is intended to describe the functions of this product. Yokogawa Electric Corporation (hereinafter simply referred to as Yokogawa) does not guarantee that these functions are suited to the particular purpose of the user.
- (4) Under absolutely no circumstances may the contents of this manual, in part or in whole, be transcribed or copied without permission.
- (5) The contents of this manual are subject to change without prior notice.
- (6) Every effort has been made to ensure accuracy in the preparation of this manual. Should any errors or omissions come to your attention however, please contact your nearest Yokogawa representative or our sales office.

■ Protection, Safety, and Prohibition Against Unauthorized Modification

- (1) In order to protect the product and the system controlled by it against damage and ensure its safe use, make certain that all of the instructions and precautions relating to safety contained in this document are strictly adhered to. Yokogawa does not guarantee safety if products are not handled according to these instructions.
- (2) The following safety symbols are used on the product and in this manual.



If this symbol is indicated on the product, the operator should refer to the explanation given in the instruction manual in order to avoid personal injury or death to either themselves or other personnel, and/or damage to the instrument. The manual describes that the operator should exercise special care to avoid shock or other dangers that may result in injury or loss of life.



Protective ground terminal:

This symbol indicates that the terminal must be connected to ground prior to operating the equipment.



Function ground terminal:

This symbol indicates that the terminal must be connected to ground prior to operating the equipment.



Alternating current.

- (3) If protection/safety circuits are to be used for the product or the system controlled by it, they should be externally installed on the product.
- (4) When you replace the parts or consumables of the product, only use those specified by Yokogawa.
- (5) Do not modify the product.

(6) This product has been approved as flameproof electrical equipment for use in a hazardous area, and hence usable in explosive atmospheres. However, when using this product in a hazardous area, abide by the conditions in the following standards:

- CSA standard (CSA C22.2 No. 213)
Location Class I, Division 2, Groups A, B, C & D
Temperature Code T4

NOTE: For the installation procedure, see page App. 6-1.

- FM standard (FM 3611)
Location Class I, Division 2, Groups A, B, C & D
Class I, Zone 2, Group IIc
Temperature Code T4

NOTE: For the installation procedure, see page App. 6-2.

(7) The suitability of the final installation is to be determined by the local authorities having jurisdiction.

■ Force Majeure

- (1) Yokogawa does not make any warranties regarding the product except those mentioned in the WARRANTY that is provided separately.
- (2) Yokogawa assumes no liability to any party for any loss or damage, direct or indirect, caused by the use or any unpredictable defect of the product.



WARNING

Do not change the setting of the following US1000 controller parameter.

[Setup parameter] - [Main menu: USMD] - [Submenu: Test]

Parameter: TST (Test mode)

This parameter is used to adjust a US1000 controller at the factory. If you change the setting of this parameter, the US1000 controller may not operate normally.



NOTE

Only personnel with an understanding of the US1000 controller and custom computation functions are qualified to change the settings of the following parameters as necessary. Those using the US1000 controller for the first time and those not knowledgeable about the custom computation function, should use the default values of the following parameters assigned to the controller.

[Setup parameter] - [Main menu: CONF] - [Submenu: DO and DI]

All the parameters under the submenus above.

If you change the settings of these parameters, some of the functions assigned to each US1000 controller mode (US mode) may not work.

Contents

Introduction	i
Checking Package Contents	ii
Documentation Conventions	iii
Notice	iv
1. US1000 Digital Indicating Controller	1-1
1.1 What is on the Front Panel?	1-2
1.2 Characters and Symbols on Digital Displays	1-3
1.3 Operation Display and Parameter Setting Display	1-4
1.4 Preparing for Operation	1-5
1.5 Factory-Set Defaults	1-6
1.6 Label Positions	1-7
2. Installing US1000 Controller	2-1
2.1 External Dimensions and Panel Dimensions	2-2
2.2 Mounting the Controller	2-3
3. Wiring 3-1	
3.1 Procedure for Wiring	3-1
3.1.1 Cables and Terminals	3-1
3.1.2 Direction of wiring	3-2
3.1.3 Preventing Noise	3-2
3.1.4 Terminal Designation	3-3
3.1.5 Wiring for Power Supply and Transmitter's Loop Power Supply	3-4
3.1.6 Attaching the Terminal Cover	3-5
3.2 Signals Assigned to Terminals	3-6
3.2.1 Terminal Assignment for US1000-00 (Basic Type)	3-7
3.2.2 Terminal Assignment for US1000-11 (Enhanced Type)	3-8
3.2.3 Terminal Assignment for US1000-21 (Position Proportional Type)	3-20
4. Setting the Basic Functions	4-1
4.1 Example of Parameter Display	4-2
4.2 Procedure for Setting the Basic Functions	4-3
4.3 Selecting the Controller Mode (US Mode)	4-4
4.4 Selecting the PV Input Type	4-6
4.5 Selecting the Control Computation and Output Types	4-9
4.6 Writing the Data Defined So Far (Parameter Initialization)	4-11
4.7 Defining the Alarm Outputs (as necessary)	4-12
4.8 Setting the Target Setpoint, Alarm Setpoints, and PID Parameters	4-15
4.9 Setting Other Functions (as necessary)	4-17
5. Customizing Operation Displays	5-1
5.1 Registering Auxiliary Operation Displays (USER Displays)	5-2
5.2 Displaying the Alarm Status	5-5
5.3 Registering Quick Parameter Call-up Functions (SELECT Displays)	5-6

6. Operation	6-1
6.1 Switching the Operation Mode	6-2
6.2 Changing the Target Setpoint (SV)	6-3
6.3 Manipulating MV	6-4
6.4 Operations on Single-Loop Type of Controller	6-5
6.5 Operations on Cascade Type of Controller	6-6
6.6 Switching Between Cascade Open and Close	6-8
6.7 Operations on Dual-loop Type of Controller	6-9
6.8 Display and Operations during Heating/Cooling Computation	6-11
6.9 Operation Mode Switching Using Contact Input	6-12
6.10 Starting Controller Operation	6-13
6.11 Auto-tuning	6-14
6.12 Manual Tuning	6-16
6.13 Stopping Controller Operation	6-17
6.14 Power Failure during Operation	6-18
7. Other Functions.....	7-1
7.1 Communication Functions	7-2
7.2 Custom Computation	7-3
7.3 D Register and I Relay	7-4
8. Maintenance.....	8-1
8.1 Cleaning	8-1
8.2 Replacement of Mounting Bracket	8-1
8.3 Limited Life Components and Maintenance	8-1
8.4 Procedure for Replacing Control Output Relays	8-2
8.5 Problems and Corrective Measures	8-3
8.5.1 Troubleshooting	8-3
8.5.2 Error Code Description	8-4
Appendix 1 Hardware Specifications	App. 1-1
Appendix 2 Engineering Units Available for the US1000	App. 2-1
Appendix 3 Operation Parameter Table	App. 3-1
Appendix 4 Setup Parameter Table	App. 4-1
Appendix 5 Parameter Map.....	App. 5-1
Appendix 6 Conditions of Use in Hazardous Areas	App. 5-1
6.1 CSA standard	App. 5-1
6.2 FM standard	App. 5-3
Index.....	1
Revision Record	i

Blank Page

1. US1000 Digital Indicating Controller

The US1000 digital indicating controller is designed with sophisticated, yet user-friendly control functions. The displays and operation keys on the front panel provide for smooth and secure operation.

● **Simplified setup**

The typical setup of the US1000's basic control function and the I/O terminal assignment are registered as the "controller mode (US mode)." Users can easily setup the controller by selecting this controller mode.

● **A wealth of displays and operating functions**

The US1000 controller has two easy-to-read digital displays and three bar graphs as analog displays. The operation mode is switched and MV output modified using the dedicated keys.

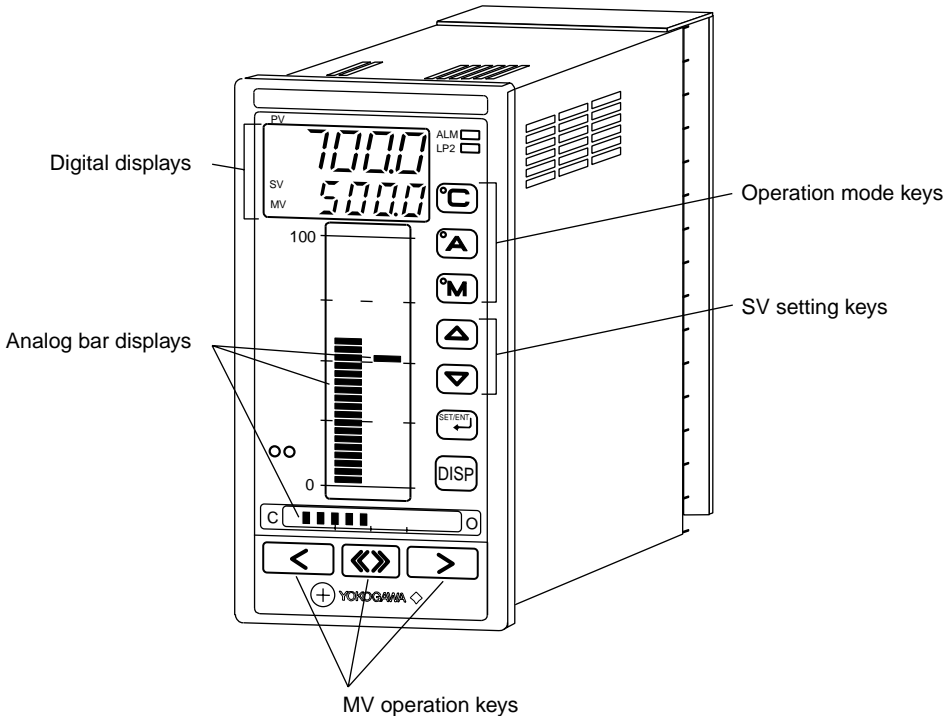

1.1 What is on the Front Panel?

The US1000 controller displays process variables (PV), target setpoint values (SV), and MV output values (MV) in two ways: on a digital display and an analog bar display. Separate keys are provided for switching the operation mode and changing SV and MV, thus operators will have no problems operating the controller from the first time they use it.

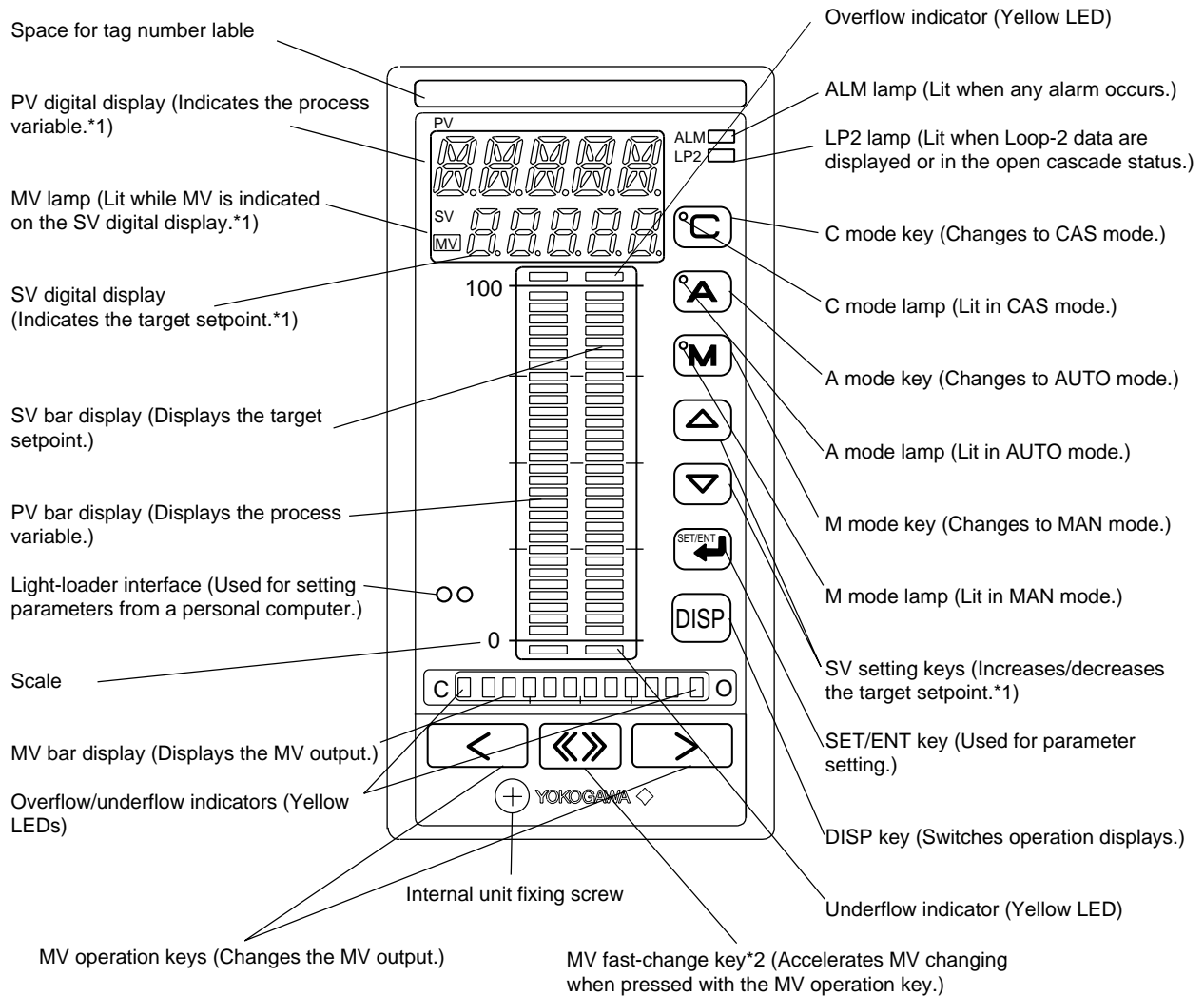

*1 This function is valid during operation. A different function is given when setting parameters.

*2 This key is invalid with the US1000-21 model (position proportional type).

1.2 Characters and Symbols on Digital Displays

The meanings of characters and symbols that appear on the PV and SV digital displays are explained here.

■ PV Digital Display

Meaning	0	1	2	3	4	5	6	7	8	9						
Display	0	1	2	3	4	5	6	7	8	9						
Meaning	A	B	C	D	E	F	G	H	I	J	K	L	M	N	O	P
Display	A	B	C	D	E	F	G	H	I	J	K	L	M	N	O	P
Meaning	Q	R	S	T	U	V	W	X	Y	Z						
Display	Q	R	S	T	U	V	W	X	Y	Z						
Meaning	-	c	-1	/	_	△	▽	<	>	°	C	°	F	Layer ^{*1}	Layer ^{*2}	
Display	-	c	-1	/	_	△	▽	<	>	°	C	°	F	Layer ^{*1}	Layer ^{*2}	

During parameter setting, one of the horizontal bar is displayed in the left-most digit of the PV digital display. Each bar indicates a different level of setting, as outlined below.

- *1 Main menu : The upper bar flashes.
 Submenu : The middle bar flashes.
 Parameter : The lower bar flashes.
- *2 When no submenu exists.
 Main menu : The upper bar flashes.
 Parameter : The lower bar flashes.

■ SV Digital Display

Meaning	0	1	2	3	4	5	6	7	8	9						
Display	0	1	2	3	4	5	6	7	8	9						
Meaning	A	B	C	D	E	F	G	H	I	J	K	L	M	N	O	P
Display	A	B	C	D	E	F	G	H	I	J	K	L	M	N	O	P
Meaning	Q	R	S	T	U	V	W	Y	Z							
Display	Q	R	S	T	U	V	W	Y	Z							
Meaning	-	c	-1	/	_	°	C	°	F							
Display	-	c	-1	/	_	°	C	°	F							

1.3 Operation Display and Parameter Setting Display



The US1000 controller shows different types of displays during operation and parameter setting. The functions given to the keys are also different between the two situations.

● **Display during operation**

- The PV digital display indicates the PV value.
- The SV digital display usually indicates the SV value, but indicates the MV value when the MV lamp is lit.
- The SV keys are used to increase and decrease the SV value.
- The analog bar graphs show PV, SV, and MV.

● **Display during parameter setting**

- The PV digital display indicates the parameter menu or parameter name.
- The SV digital display indicates the set data of a parameter.
- The SV keys are used to increase and decrease the set data of a parameter.
- The analog bar graphs remain the same as they were during operation.

To change from operation to parameter setting, press the  key for 3 to 6 seconds (this period of time is described as just “for 3 seconds” hereafter). To change from the parameter setting display back to the operation display, press the  key.

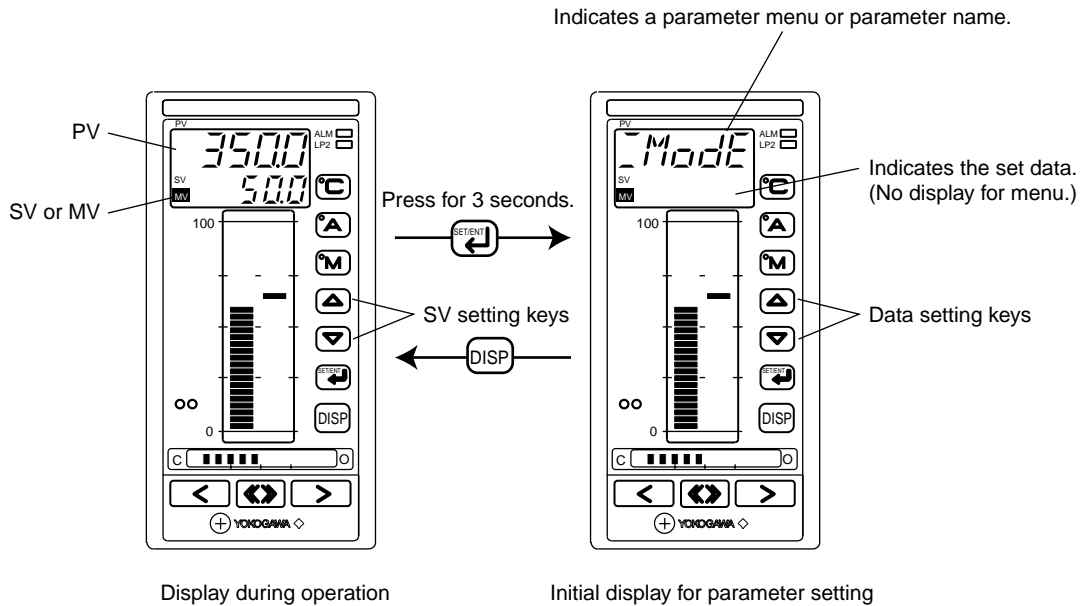

1.4 Preparing for Operation

The US1000 controller must be set up before it can be operated. Set up the controller in the sequence shown below.



NOTE

The US1000 controller has no power switch. It starts operating and its control action as soon as it is plugged in, i.e., connected to its power source. Thus, the controller output should not be connected to the controlled equipment until just before operation.

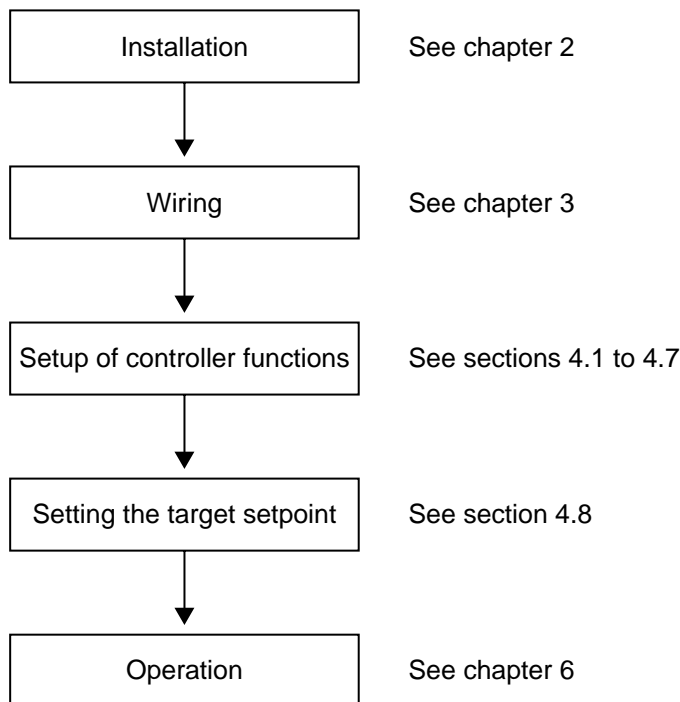

Also read section 4.9, “Setting Other Functions,” and chapter 5, “Customizing Operation Displays” as necessary.



TIP

- If you use the custom computation function, setup the controller functions and set the target setpoint using the LL1200 PC-Based Custom Computation Building Tool (optional).
- If you use the communication function, you should also read the ‘US1000 Digital Indicating Controller Communication Functions (IM 5D1A01-10E)’ manual.

1.5 Factory-Set Defaults

When the US1000 controller is delivered from the factory, it is set up in the controller mode (US mode) for “single-loop control.” That is, it is set up to perform PID control for a single loop. The other items set are as listed below. To change the factory-set defaults, refer to the sections shown in the table.

Item	Factory-set default	Reference
Controller mode (US mode)	Single-loop control	Section 4.3, ‘Selecting the controller mode (US mode).’
Input type	Standard signal	Section 4.4, ‘Selecting the PV input type.’
Input terminal	AIN1	Section 4.4, ‘Selecting the PV input type.’
Input range	1.000 to 5.000 V	Section 4.4, ‘Selecting the PV input type.’
Engineering unit	°C	Section 4.4, ‘Selecting the PV input type.’
Input computation	None	Section 4.9, ‘Setting other functions.’
Analog burnout action	Off	Section 4.9, ‘Setting other functions.’
Direct/reverse control action	Reverse	Section 4.9, ‘Setting other functions.’
Control computation type	Continuous PID	Section 4.5, ‘Selecting the control computation and output types.’
Output type	Current output	Section 4.5, ‘Selecting the control computation and output types.’
Output terminal	OUT1A (4-20 mA)	Section 4.5, ‘Selecting the control computation and output types.’
Alarm output terminals	DO1 (PV high limit alarm) DO2 (PV low limit alarm) DO3 (PV high limit alarm)	Section 4.7, ‘Defining the alarm output.’
Auto-tuning	Off	Section 6.11, ‘Auto-tuning.’
SUPER function	Off	Section 4.9, ‘Setting other functions.’
Control period	200 ms	The separate ‘US1000 Digital Indicating Controller Functions’ (IM 5D1A01-02E) manual.



See Also

The initial values of all parameters listed in Appendix 3 and Appendix 4.

1.6 Label Positions

Stick the accessory labels in the positions shown below. Be careful not to cover the light-loader interface or any display with the labels.

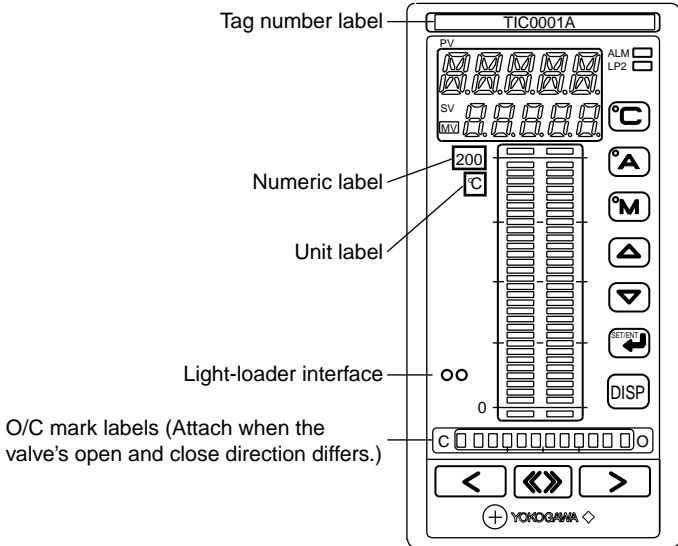

Blank Page

2. Installing US1000 Controller

Before using the controller, install it according to the instructions given in this chapter.



CAUTION

To prevent electrical shock, only apply power to the controller when it is mounted on the panel.



NOTE

To install the controller, select a location where:

- no-one may accidentally touch the terminals
 - mechanical vibrations are minimal
 - no corrosive gas
 - temperature can be maintained at about 23°C and with minimal fluctuation
 - no direct heat radiation
 - no magnetic disturbances result
 - no splashing water
 - no flammable materials
 - the terminal board (reference junction compensation element, etc.) is protected from wind
-

The housing of the controller is made of modified polyphenylene-ether resin and polycarbonate. Be sure to install the controller away from highly flammable items. Never place the controller directly on highly flammable items.

If the controller has to be installed close to highly flammable items or equipment, be sure to surround the controller with shielding panels, placed at least 150 mm away from every side. These panels should be made of either 1.43-mm thick metal-plated iron plates or 1.6-mm thick uncoated iron plates.

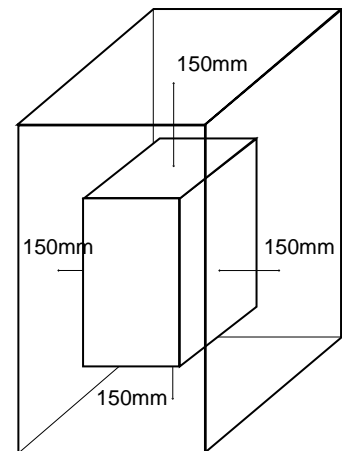

2.1 External Dimensions and Panel Dimensions

The external dimensions and panel cutout dimensions are as shown below.

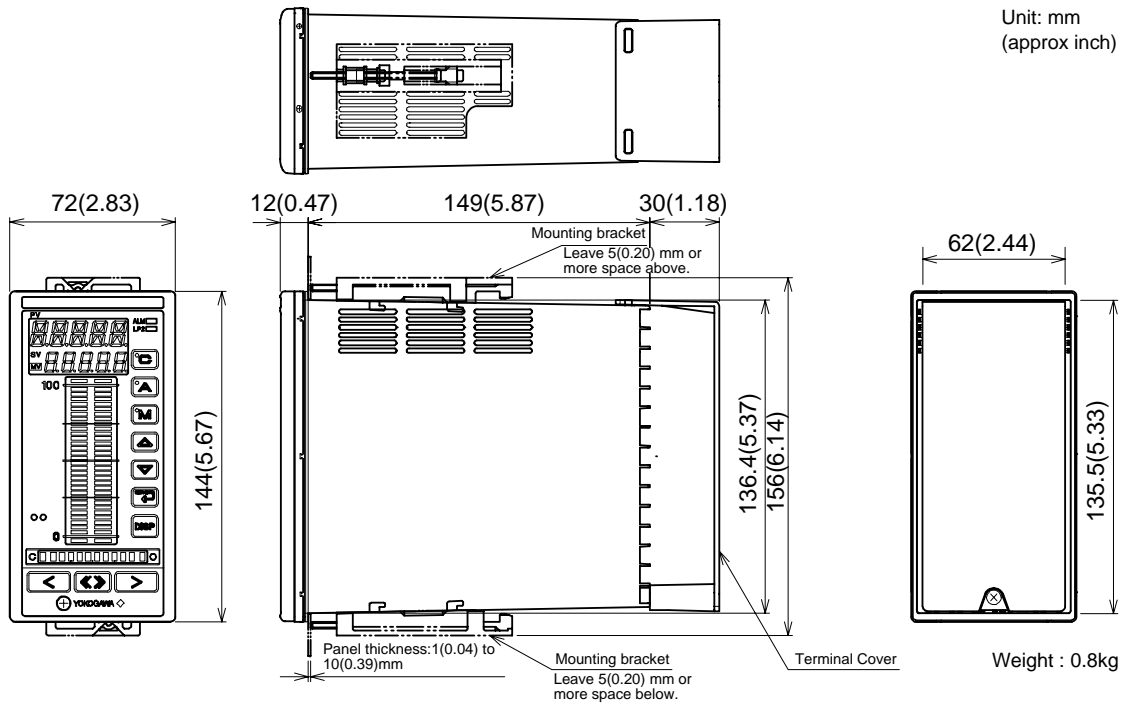

External Dimensions

(General mounting)

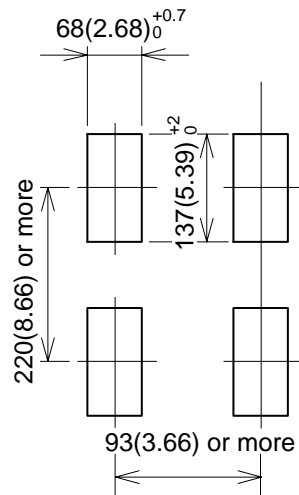

(Side-by-side close mounting)

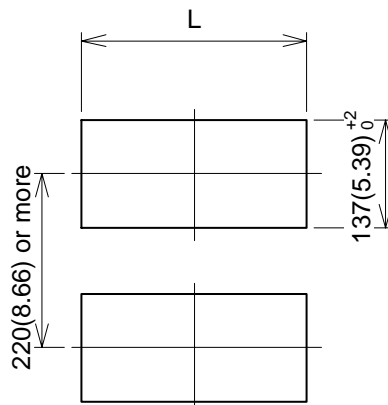

L : refer to the Table 1

Panel cutout width for side-by-side close mounting
[Table 1]

Number of units	L (mm)	L (inch)
2	140	5.51
3	212	8.35
4	284	11.18
5	356	14.02
6	428	16.85
7	500	19.69
8	572	22.52
9	644	25.35
10	716	28.19
11	788	31.02
12	860	33.86
13	932	36.69
14	1004	39.53

Panel Cutout Dimensions

2.2 Mounting the Controller

■ Mounting Procedure

1. Cut the mounting panel as specified by the panel cutout dimensions on the previous page.
2. Insert the controller into the opening on the rear terminal board.
3. Attach the mounting brackets to the top and bottom of the controller, and fix the controller to the mounting panel.

2.

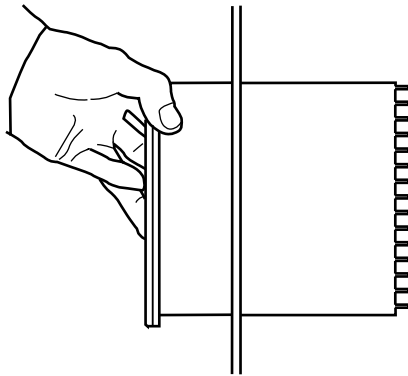

3.

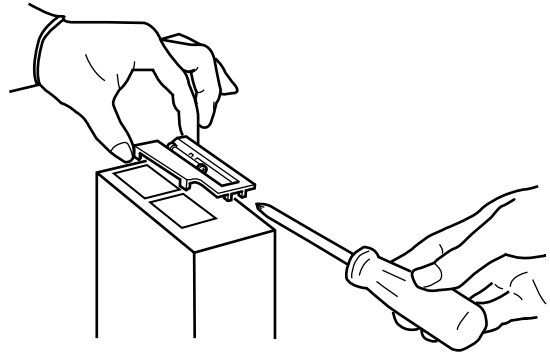

NOTE

- Do not over-tighten the screws; doing so may damage the controller housing and brackets. (Recommended tightening torque: 0.2 N•m (2 kgf•cm) or less)
- Mount the controller within 30 degrees from horizontal so that it faces upward. Do not mount it facing downward.

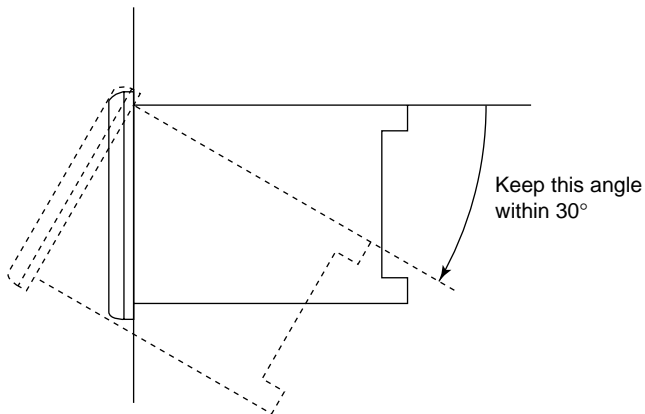

Blank Page

3. Wiring

This chapter describes the wiring procedure and terminal assignment of the US1000 controller. The optimum sets of signals are automatically assigned to the terminals according to the model and suffix code of your controller, the controller mode (US mode), and the type of control computation output.



See Also

- Section 4.3, "Selecting the Controller Mode (US Mode)," for information on the controller modes (US modes).
- Section 4.5, "Selecting the Control Computation and Output Types," for information on the control computations.



CAUTION

- Before you start wiring, turn off the power supply source and use a tester to check that the controller and cables are not receiving any power.
- Never touch a terminal when power is being supplied; you will get an electrical shock if you do.
- Be careful to connect the correct polarities. Connecting the wrong polarity may result in a serious accident.
- If the controller and any external equipment connected to it are to be used in a hazardous area (as non-incendive equipment), the external equipment and the wiring conditions must satisfy the requirements specified in Appendix 6, "Conditions of Use in Hazardous Areas." If these conditions are not satisfied, the controller itself may be the source of a fire.

3.1 Procedure for Wiring

This section describes the cables used for wiring, the terminal assignment, and the wiring for power supply. Once wiring is complete, a terminal cover should be attached as outlined in subsection 3.1.6.

3.1.1 Cables and Terminals

For the thermocouple input, use shielded compensating lead wires. The resistance temperature detector (RTD) input requires shielded cables with low resistance and no resistance differential between the three wires. The specifications for the cables and terminals used in the wiring are as follows.

- Power supply wiring: 600 V vinyl insulation electric wire, JIS C 3307, 0.9 to 2.0 mm²
- Thermocouple wiring: Shielded compensating lead wire, JIS C 1610
- RTD input wiring: Shielded 3-core wire, UL2482 (product of Hitachi Cable)
- Terminal: Crimp-on terminals with insulation sleeves and of a size suitable for M3.5 screws (see the figure below).
- Terminal tightening torque: 0.8 N•m (8 kgf•cm) or less

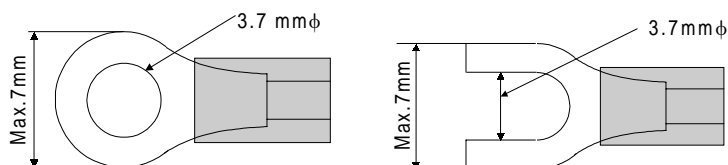

3.1.2 Direction of wiring

After connecting cables to the rear terminals, adjust the wiring so that the cables run in the direction shown below.

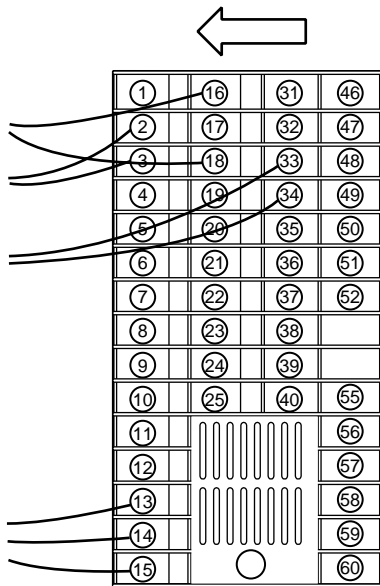

3.1.3 Preventing Noise



NOTE

-
- To prevent electromagnetic wave radiation, use shielded wires for the wiring for the thermocouple input, RTD input, DC input, current output or voltage pulse output. The shield must be grounded.
 - Bundle the connected cables together tightly.
-

Consider the following noise-prevention points when performing wiring.

- Keep the input circuit wires as far away as possible from the power lines of other equipment.
- The use of shielded wires is effective against noises from electrostatic induction. Connect shielding to the grounding terminal if necessary. Be sure to ground each wire independently.
- Twining input wires at short regular intervals can be quite effective at eliminating the noise from electromagnetic induction.
- Keep the power supply wiring more than 10 cm away from the signal wiring.

3.1.4 Terminal Designation

The terminals at the rear of the US1000 controller are arranged as shown below. Perform wiring according to this figure. For information on the wiring for the power supply and the transmitter's loop power supply, read subsection 3.1.5. Refer to section 3.2 to find the signal assigned to each terminal.

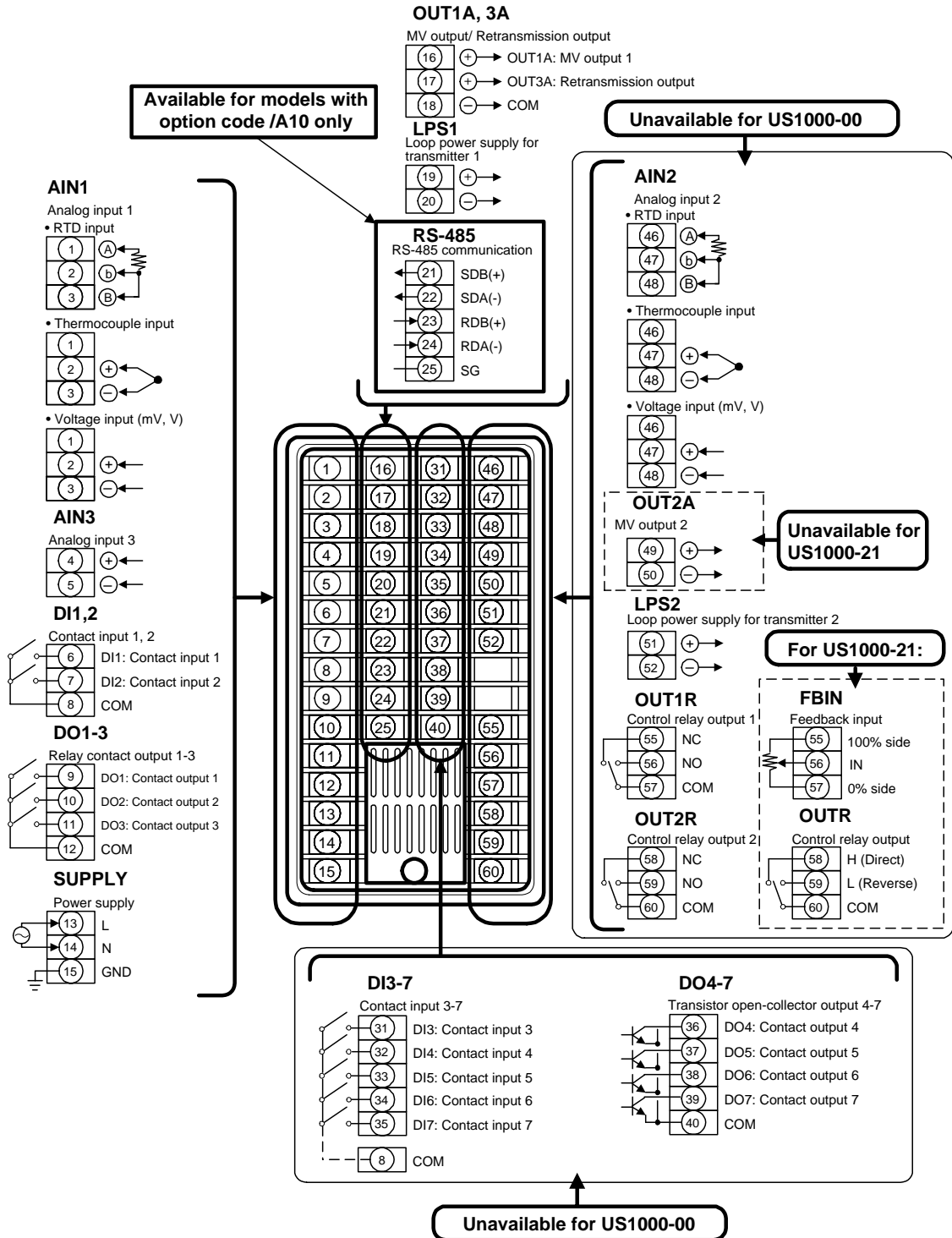

Figure Terminal Assignment

3.1.5 Wiring for Power Supply and Transmitter's Loop Power Supply

Perform wiring for the power supply and the transmitter's loop power supply as instructed below.

■ Wiring for Power Supply

- Use a single-phase power source.
- Use wires or cables with a minimum performance equivalent to that of 600 V vinyl insulation electric wires (JIS C 3307).
- If the source has a lot of noise, use an insulation transformer and line filter as shown in the figure below.

The recommended line filter is TDK's ZAC2205-00U.

- When this noise-prevention measure is taken, keep the primary and secondary power cables well apart.
- To ensure safety, install a circuit breaker switch or an equivalent safety device and be sure that usage instructions for the device are clearly displayed.

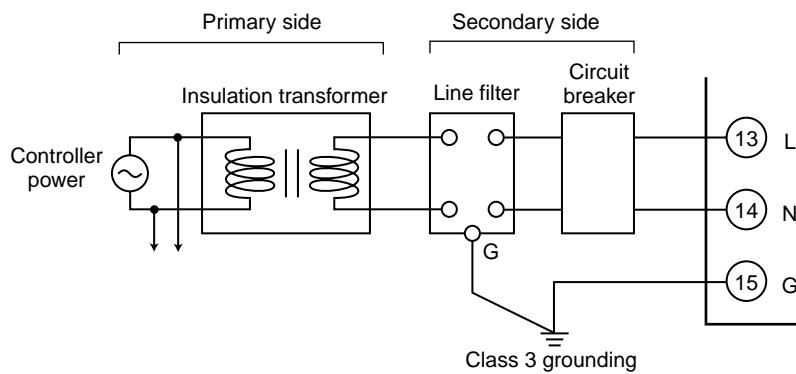

■ Wiring for Loop Power Supply of Transmitter

Approximately 25.5 V DC power can be supplied to a two-wire sensor requiring a power supply. Yokogawa's Brain transmitter with communication function and the dedicated Brain terminal can be used.

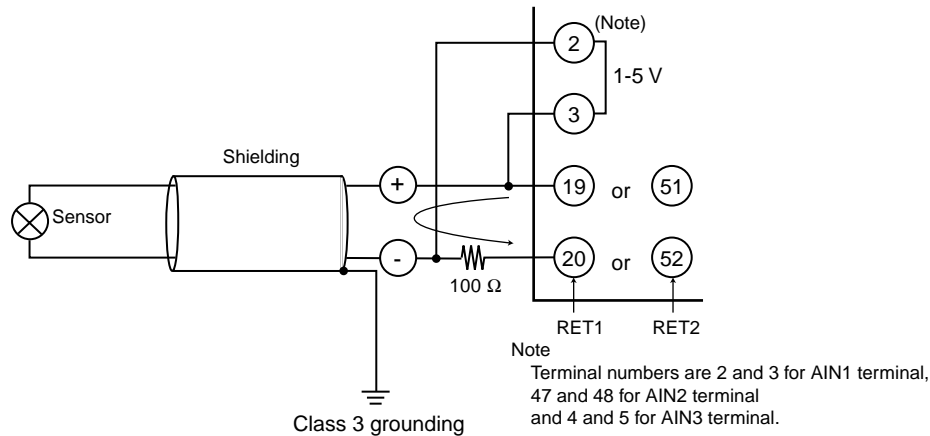

3.1.6 Attaching the Terminal Cover

When you complete the wiring, attach the terminal cover as follows to prevent electrical shocks.

1. Fit the holes in the upper part of the terminal cover over the protrusions in the upper part of the housing.
2. Insert the screw at the bottom of the terminal cover into the screw hole in the rear of the controller and tighten it.

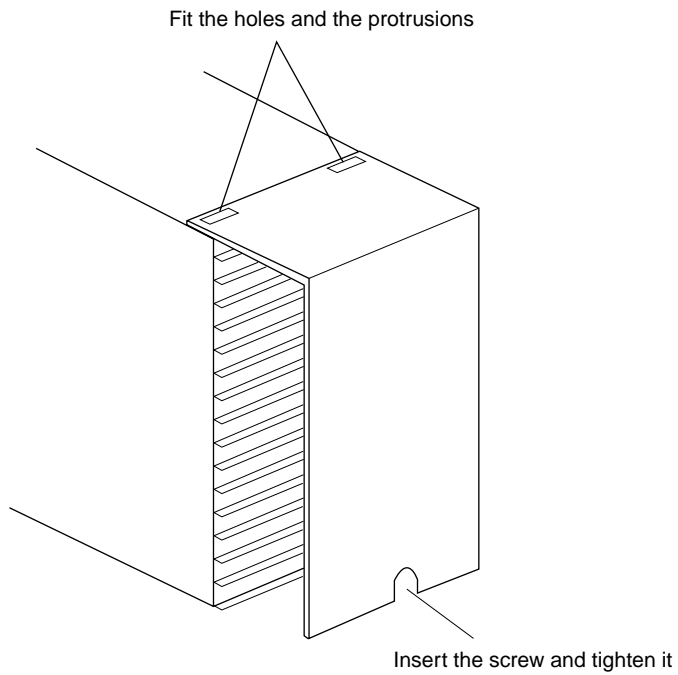

3.2 Signals Assigned to Terminals

The US1000 controller has different signals assigned to terminals depending on the controller's model and suffix code, the controller mode (US mode), and the type of the control computation. Refer to the relevant subsection according to your controller's model and suffix code.

Model US1000-00: Subsection 3.2.1

Model US1000-11: Subsection 3.2.2

Model US1000-21: Subsection 3.2.3

In each subsection, tables are given for each controller mode (US mode) and control computation type. Refer to the table that applies to your controller's settings.



See Also

- Section 4.3, "Selecting Controller Mode (US Mode)," for information on the controller modes (US modes).
- Section 4.5, "Selecting Control Computation and Output Types," for information on the control computations.

● Contact Input Function

The functions assigned to the contact inputs are as follow.

- RUN/STOP switchover: The controller is in STOP status when the contact is on, and in the RUN status when the contact is off.
- CAS/AUTO/MAN mode selection:
When the contact is turned from off to on, the operation mode changes to the corresponding mode.
- Tracking switching: Tracking signal of AIN2 or AIN3 is effective when the contact is on.
- OPEN/CLOSE switchover: Cascade control is disabled (OPEN) when the contact is on; cascade control is enabled (CLOSE) when contact is off.
- 'PV-hold and MAN mode' or 'AUTO mode':
The controller holds PV in MAN mode when the contact is on, and is in the AUTO mode when contact is off.

● Alarm Output 1 to 4

The initial alarm types of the alarm output 1 to 4 are:

- Alarm output 1: PV high limit
- Alarm output 2: PV low limit
- Alarm output 3: PV high limit (secondary)
- Alarm output 4: PV low limit (secondary)

To change the alarm type assignments, refer to section 4.7, "Defining Alarm Outputs."

3.2.1 Terminal Assignment for US1000-00 (Basic Type)

- **US1000-00: Single-loop control (US mode 1)**
- US1000-00: Cascade primary-loop control (US mode 2)**
- US1000-00: Cascade secondary-loop control (US mode 3)**
- US1000-00: Cascade control (US mode 4)**

Terminal Code	Terminal No.	Controller mode (US mode)			
		US Mode 1	US Mode 2	US Mode 3	US Mode 4
AIN1	1 - 3	PV input	PV input	PV input	Primary-side PV input
AIN3	4, 5	Cascade input or feedforward input	Tracking input	Cascade input	Secondary-side PV input
DI1	6, 8	RUN/STOP switchover	RUN/STOP switchover	RUN/STOP switchover	RUN/STOP switchover
DI2	7, 8	MAN mode selection	Tracking switching	CAS → AUTO mode when the contact is off	OPEN/CLOSE switchover
LPS1	19, 20	Loop power supply for transmitter 1	Loop power supply for transmitter 1	Loop power supply for transmitter 1	Loop power supply for transmitter 1
OUT1A	16, 18	Voltage pulse or current output	Current output	Voltage pulse or current output	Voltage pulse or current output
DO1	9, 12	Alarm output 1	Alarm output 1	Alarm output 1	Alarm output 1
DO2	10, 12	Alarm output 2	Alarm output 2	Alarm output 2	Alarm output 2
DO3	11, 12	Alarm output 3	Contact off during error	Contact off when CAS mode	Alarm output 3

The output from the OUT1A terminal will be voltage pulse output when the control computation is "time proportional PID," and current output when it is "continuous PID."

- **US1000-00: Loop control for backup (US mode 5)**
- US1000-00: Loop control with PV switching (US mode 6)**
- US1000-00: Loop control with PV auto-selector (US mode 7)**
- US1000-00: Loop control with PV-hold function (US mode 8)**

Terminal Code	Terminal No.	Controller mode (US mode)			
		US Mode 5	US Mode 6	US Mode 7	US Mode 8
AIN1	1 - 3	PV input	PV input 1	PV input 1	PV input
AIN3	4, 5	Tracking input	PV input 2	PV input 2	Cascade input, feedforward input, or tracking input
DI1	6, 8	RUN/STOP switchover	RUN/STOP switchover	RUN/STOP switchover	RUN/STOP switchover
DI2	7, 8	Tracking switching	PV switching	MAN mode selection	'PV-hold and MAN mode' or 'AUTO mode'
LPS1	19, 20	Loop power supply for transmitter 1	Loop power supply for transmitter 1	Loop power supply for transmitter 1	Loop power supply for transmitter 1
OUT1A	16, 18	Voltage pulse or current output	Voltage pulse or current output	Voltage pulse or current output	Voltage pulse or current output
DO1	9, 12	Alarm output 1	Alarm output 1	Alarm output 1	Alarm output 1
DO2	10, 12	Alarm output 2	Alarm output 2	Alarm output 2	Alarm output 2
DO3	11, 12	Contact off during error	Alarm output 3	Alarm output 3	Alarm output 3

The output from the OUT1A terminal will be voltage pulse output when the control computation is "time proportional PID," and current output when it is "continuous PID."

3.2.2 Terminal Assignment for US1000-11 (Enhanced Type)

■ US1000-11: Single-loop control (US mode 1)

Terminal Code	Terminal No.	Control Computation (MVS1 Set Value)			
		Time proportional PID (0, 1) Continuous PID (2) ON/OFF computation (3)	Heating/cooling computation (4 - 6)	Heating/cooling computation (7 - 9)	Heating/cooling computation (10 - 12)
AIN1	1 - 3	PV input	PV input	PV input	PV input
AIN2	46 - 48	No function	No function	No function	No function
AIN3	4, 5	Cascade input or feedforward input	Cascade input or feedforward input	Cascade input or feedforward input	Cascade input or feedforward input
DI1	6, 8	RUN/STOP switchover	RUN/STOP switchover	RUN/STOP switchover	RUN/STOP switchover
DI2	7, 8	MAN mode selection	MAN mode selection	MAN mode selection	MAN mode selection
DI3	31, 8	AUTO mode selection	AUTO mode selection	AUTO mode selection	AUTO mode selection
DI4	32, 8	Bit-0 of SV No. setting	Bit-0 of SV No. setting	Bit-0 of SV No. setting	Bit-0 of SV No. setting
DI5	33, 8	Bit-1 of SV No. setting	Bit-1 of SV No. setting	Bit-1 of SV No. setting	Bit-1 of SV No. setting
DI6	34, 8	Bit-2 of SV No. setting	Bit-2 of SV No. setting	Bit-2 of SV No. setting	Bit-2 of SV No. setting
DI7	35, 8	Bit-3 of SV No. setting	Bit-3 of SV No. setting	Bit-3 of SV No. setting	Bit-3 of SV No. setting
LPS1	19, 20	Loop power supply for transmitter 1	Loop power supply for transmitter 1	Loop power supply for transmitter 1	Loop power supply for transmitter 1
LPS2	51, 52	Loop power supply for transmitter 2	Loop power supply for transmitter 2	Loop power supply for transmitter 2	Loop power supply for transmitter 2
OUT1A	16, 18	Retransmission output (0, 3) Voltage pulse output (1) Current output (2)	Retransmission output (4) Heating pulse output (5) Heating current output (6)	Retransmission output (7) Heating pulse output (8) Heating current output (9)	Retransmission output (10) Heating pulse output (11) Heating current output (12)
OUT2A	49, 50	Retransmission current output 2	Retransmission current output 2	Cooling pulse output	Cooling current output
OUT3A	17, 18	Retransmission voltage output 3	Retransmission voltage output 3	Retransmission voltage output 3	Retransmission voltage output 3
DO1	9, 12	Alarm output 1	Alarm output 1	Alarm output 1	Alarm output 1
DO2	10, 12	Alarm output 2	Alarm output 2	Alarm output 2	Alarm output 2
DO3	11, 12	Alarm output 3	Alarm output 3	Alarm output 3	Alarm output 3
DO4	36, 40	Alarm output 4	Alarm output 4	Alarm output 4	Alarm output 4
DO5	37, 40	No function	No function	No function	No function
DO6	38, 40	No function	No function	No function	No function
DO7	39, 40	FAIL output	FAIL output	FAIL output	FAIL output
OUT1R	55 - 57	Control relay output (0, 3) Alarm output 4 (1, 2)	Heating control relay output (4) Alarm output 4 (5, 6)	Heating control relay output (7) Alarm output 4 (8, 9)	Heating control relay output (10) Alarm output 4 (11, 12)
OUT2R	58 - 60	Alarm output 3	Cooling control relay output	Alarm output 3	Alarm output 3

■ US1000-11: Cascade primary-loop control (US mode 2)

Terminal Code	Terminal No.	Control Computation (MVS1 Set Value)
		Continuous PID (2)
AIN1	1 - 3	PV input
AIN2	46 - 48	Cascade input or feedforward input
AIN3	4, 5	Tracking input
DI1	6, 8	RUN/STOP switchover
DI2	7, 8	Tracking switching
DI3	31, 8	MAN mode selection
DI4	32, 8	Bit-0 of SV No. setting
DI5	33, 8	Bit-1 of SV No. setting
DI6	34, 8	Bit-2 of SV No. setting
DI7	35, 8	Bit-3 of SV No. setting
LPS1	19, 20	Loop power supply for transmitter 1
LPS2	51, 52	Loop power supply for transmitter 2
OUT1A	16, 18	Current output
OUT2A	49, 50	Retransmission current output 2
OUT3A	17, 18	Retransmission voltage output 3
DO1	9, 12	Alarm output 1
DO2	10, 12	Alarm output 2
DO3	11, 12	Contact off during error
DO4	36, 40	Alarm output 4
DO5	37, 40	Alarm output 3
DO6	38, 40	No function
DO7	39, 40	FAIL output
OUT1R	55 - 57	Alarm output 4
OUT2R	58 - 60	Alarm output 3

■ US1000-11: Cascade secondary-loop control (US mode 3)

Terminal Code	Terminal No.	Control Computation (MVS1 Set Value)			
		Time proportional PID (0, 1) Continuous PID (2) ON/OFF computation (3)	Heating/cooling computation (4 - 6)	Heating/cooling computation (7 - 9)	Heating/cooling computation (10 - 12)
AIN1	1 - 3	PV input	PV input	PV input	PV input
AIN2	46 - 48	Feedforward input	Feedforward input	Feedforward input	Feedforward input
AIN3	4, 5	Cascade input	Cascade input	Cascade input	Cascade input
DI1	6, 8	RUN/STOP switchover	RUN/STOP switchover	RUN/STOP switchover	RUN/STOP switchover
DI2	7, 8	CAS → AUTO mode when the contact is off	CAS → AUTO mode when the contact is off	CAS → AUTO mode when the contact is off	CAS → AUTO mode when the contact is off
DI3	31, 8	MAN mode selection	MAN mode selection	MAN mode selection	MAN mode selection
DI4	32, 8	AUTO mode selection	AUTO mode selection	AUTO mode selection	AUTO mode selection
DI5	33, 8	CAS mode selection	CAS mode selection	CAS mode selection	CAS mode selection
DI6	34, 8	Message input	Message input	Message input	Message input
DI7	35, 8	No function	No function	No function	No function
LPS1	19, 20	Loop power supply for transmitter 1	Loop power supply for transmitter 1	Loop power supply for transmitter 1	Loop power supply for transmitter 1
LPS2	51, 52	Loop power supply for transmitter 2	Loop power supply for transmitter 2	Loop power supply for transmitter 2	Loop power supply for transmitter 2
OUT1A	16, 18	Retransmission output (0, 3) Voltage pulse output (1) Current output (2)	Retransmission output (4) Heating pulse output (5) Heating current output (6)	Retransmission output (7) Heating pulse output (8) Heating current output (9)	Retransmission output (10) Heating pulse output (11) Heating current output (12)
OUT2A	49, 50	Retransmission current output 2	Retransmission current output 2	Cooling pulse output	Cooling current output
OUT3A	17, 18	Retransmission voltage output 3	Retransmission voltage output 3	Retransmission voltage output 3	Retransmission voltage output 3
DO1	9, 12	Alarm output 1	Alarm output 1	Alarm output 1	Alarm output 1
DO2	10, 12	Alarm output 2	Alarm output 2	Alarm output 2	Alarm output 2
DO3	11, 12	CAS output	CAS output	CAS output	CAS output
DO4	36, 40	Alarm output 4	Alarm output 4	Alarm output 4	Alarm output 4
DO5	37, 40	Alarm output 3	Alarm output 3	Alarm output 3	Alarm output 3
DO6	38, 40	No function	No function	No function	No function
DO7	39, 40	FAIL output	FAIL output	FAIL output	FAIL output
OUT1R	55 - 57	Control relay output (0, 3) Alarm output 4 (1, 2)	Heating control relay output (4) Alarm output 4 (5, 6)	Heating control relay output (7) Alarm output 4 (8, 9)	Heating control relay output (10) Alarm output 4 (11, 12)
OUT2R	58 - 60	Alarm output 3	Cooling control relay output	Alarm output 3	Alarm output 3

■ US1000-11: Cascade control (US mode 4)

Terminal Code	Terminal No.	Control Computation (MVS2 Set value)			
		Time proportional PID (0, 1) Continuous PID (2) ON/OFF computation (3)	Heating/cooling computation (4 - 6)	Heating/cooling computation (7 - 9)	Heating/cooling computation (10 - 12)
AIN1	1 - 3	Primary-side PV input	Primary-side PV input	Primary-side PV input	Primary-side PV input
AIN2	46 - 48	Cascade input or feedforward input	Cascade input or feedforward input	Cascade input or feedforward input	Cascade input or feedforward input
AIN3	4, 5	Secondary-side PV input	Secondary-side PV input	Secondary-side PV input	Secondary-side PV input
DI1	6, 8	RUN/STOP switchover	RUN/STOP switchover	RUN/STOP switchover	RUN/STOP switchover
DI2	7, 8	OPEN/CLOSE switchover	OPEN/CLOSE switchover	OPEN/CLOSE switchover	OPEN/CLOSE switchover
DI3	31, 8	MAN mode selection	MAN mode selection	MAN mode selection	MAN mode selection
DI4	32, 8	AUTO mode selection	AUTO mode selection	AUTO mode selection	AUTO mode selection
DI5	33, 8	CAS mode selection	CAS mode selection	CAS mode selection	CAS mode selection
DI6	34, 8	Message input	Message input	Message input	Message input
DI7	35, 8	No function	No function	No function	No function
LPS1	19, 20	Loop power supply for transmitter 1	Loop power supply for transmitter 1	Loop power supply for transmitter 1	Loop power supply for transmitter 1
LPS2	51, 52	Loop power supply for transmitter 2	Loop power supply for transmitter 2	Loop power supply for transmitter 2	Loop power supply for transmitter 2
OUT1A	16, 18	Retransmission output (0, 3) Voltage pulse output (1) Current output (2)	Retransmission output (4) Heating pulse output (5) Heating current output (6)	Retransmission output (7) Heating pulse output (8) Heating current output (9)	Retransmission output (10) Heating pulse output (11) Heating current output (12)
OUT2A	49, 50	Retransmission current output 2	Retransmission current output 2	Cooling pulse output	Cooling current output
OUT3A	17, 18	Retransmission voltage output 3	Retransmission voltage output 3	Retransmission voltage output 3	Retransmission voltage output 3
DO1	9, 12	Alarm output 1	Alarm output 1	Alarm output 1	Alarm output 1
DO2	10, 12	Alarm output 2	Alarm output 2	Alarm output 2	Alarm output 2
DO3	11, 12	Alarm output 3	Alarm output 3	Alarm output 3	Alarm output 3
DO4	36, 40	Alarm output 4	Alarm output 4	Alarm output 4	Alarm output 4
DO5	37, 40	No function	No function	No function	No function
DO6	38, 40	No function	No function	No function	No function
DO7	39, 40	FAIL output	FAIL output	FAIL output	FAIL output
OUT1R	55 - 57	Control relay output (0, 3) Alarm output 4 (1, 2)	Heating control relay output (4) Alarm output 4 (5, 6)	Heating control relay output (7) Alarm output 4 (8, 9)	Heating control relay output (10) Alarm output 4 (11, 12)
OUT2R	58 - 60	Alarm output 3	Cooling control relay output	Alarm output 3	Alarm output 3

■ US1000-11: Loop control for backup (US mode 5)

Terminal Code	Terminal No.	Control Computation (MVS1 Set value)			
		Time proportional PID (0, 1) Continuous PID (2) ON/OFF computation (3)	Heating/cooling computation (4 - 6)	Heating/cooling computation (7 - 9)	Heating/cooling computation (10 - 12)
AIN1	1 - 3	PV input	PV input	PV input	PV input
AIN2	46 - 48	Cascade input or feedforward input	Cascade input or feedforward input	Cascade input or feedforward input	Cascade input or feedforward input
AIN3	4, 5	Tracking input	Tracking input	Tracking input	Tracking input
DI1	6, 8	RUN/STOP switchover	RUN/STOP switchover	RUN/STOP switchover	RUN/STOP switchover
DI2	7, 8	Tracking switching	Tracking switching	Tracking switching	Tracking switching
DI3	31, 8	MAN mode selection	MAN mode selection	MAN mode selection	MAN mode selection
DI4	32, 8	Bit-0 of SV No. setting	Bit-0 of SV No. setting	Bit-0 of SV No. setting	Bit-0 of SV No. setting
DI5	33, 8	Bit-1 of SV No. setting	Bit-1 of SV No. setting	Bit-1 of SV No. setting	Bit-1 of SV No. setting
DI6	34, 8	Bit-2 of SV No. setting	Bit-2 of SV No. setting	Bit-2 of SV No. setting	Bit-2 of SV No. setting
DI7	35, 8	Bit-3 of SV No. setting	Bit-3 of SV No. setting	Bit-3 of SV No. setting	Bit-3 of SV No. setting
LPS1	19, 20	Loop power supply for transmitter 1	Loop power supply for transmitter 1	Loop power supply for transmitter 1	Loop power supply for transmitter 1
LPS2	51, 52	Loop power supply for transmitter 2	Loop power supply for transmitter 2	Loop power supply for transmitter 2	Loop power supply for transmitter 2
OUT1A	16, 18	Retransmission output (0, 3) Voltage pulse output (1) Current output (2)	Retransmission output (4) Heating pulse output (5) Heating current output (6)	Retransmission output (7) Heating pulse output (8) Heating current output (9)	Retransmission output (10) Heating pulse output (11) Heating current output (12)
OUT2A	49, 50	Retransmission current output 2	Retransmission current output 2	Cooling pulse output	Cooling current output
OUT3A	17, 18	Retransmission voltage output 3	Retransmission voltage output 3	Retransmission voltage output 3	Retransmission voltage output 3
DO1	9, 12	Alarm output 1	Alarm output 1	Alarm output 1	Alarm output 1
DO2	10, 12	Alarm output 2	Alarm output 2	Alarm output 2	Alarm output 2
DO3	11, 12	Error output	Error output	Error output	Error output
DO4	36, 40	Alarm output 4	Alarm output 4	Alarm output 4	Alarm output 4
DO5	37, 40	Alarm output 3	Alarm output 3	Alarm output 3	Alarm output 3
DO6	38, 40	No function	No function	No function	No function
DO7	39, 40	FAIL output	FAIL output	FAIL output	FAIL output
OUT1R	55 - 57	Control relay output (0, 3) Alarm output 4 (1, 2)	Heating control relay output (4) Alarm output 4 (5, 6)	Heating control relay output (7) Alarm output 4 (8, 9)	Heating control relay output (10) Alarm output 4 (11, 12)
OUT2R	58 - 60	Alarm output 3	Cooling control relay output	Alarm output 3	Alarm output 3

■ US1000-11: Loop control with PV switching (US mode 6)

Terminal Code	Terminal No.	Control Computation (MVS1 Set Value)			
		Time proportional PID (0, 1) Continuous PID (2) ON/OFF computation (3)	Heating/cooling computation (4 - 6)	Heating/cooling computation (7 - 9)	Heating/cooling computation (10 - 12)
AIN1	1 - 3	PV input 1	PV input 1	PV input 1	PV input 1
AIN2	46 - 48	Cascade input, feedforward input, or tracking input	Cascade input, feedforward input, or tracking input	Cascade input, feedforward input, or tracking input	Cascade input, feedforward input, or tracking input
AIN3	4, 5	PV input 2	PV input 2	PV input 2	PV input 2
DI1	6, 8	RUN/STOP switchover	RUN/STOP switchover	RUN/STOP switchover	RUN/STOP switchover
DI2	7, 8	Dual-PV switching	Dual-PV switching	Dual-PV switching	Dual-PV switching
DI3	31, 8	MAN mode selection	MAN mode selection	MAN mode selection	MAN mode selection
DI4	32, 8	Bit-0 of SV No. setting	Bit-0 of SV No. setting	Bit-0 of SV No. setting	Bit-0 of SV No. setting
DI5	33, 8	Bit-1 of SV No. setting	Bit-1 of SV No. setting	Bit-1 of SV No. setting	Bit-1 of SV No. setting
DI6	34, 8	Bit-2 of SV No. setting	Bit-2 of SV No. setting	Bit-2 of SV No. setting	Bit-2 of SV No. setting
DI7	35, 8	Bit-3 of SV No. setting	Bit-3 of SV No. setting	Bit-3 of SV No. setting	Bit-3 of SV No. setting
LPS1	19, 20	Loop power supply for transmitter 1	Loop power supply for transmitter 1	Loop power supply for transmitter 1	Loop power supply for transmitter 1
LPS2	51, 52	Loop power supply for transmitter 2	Loop power supply for transmitter 2	Loop power supply for transmitter 2	Loop power supply for transmitter 2
OUT1A	16, 18	Retransmission output (0, 3) Voltage pulse output (1) Current output (2)	Retransmission output (4) Heating pulse output (5) Heating current output (6)	Retransmission output (7) Heating pulse output (8) Heating current output (9)	Retransmission output (10) Heating pulse output (11) Heating current output (12)
OUT2A	49, 50	Retransmission current output 2	Retransmission current output 2	Cooling pulse output	Cooling current output
OUT3A	17, 18	Retransmission voltage output 3	Retransmission voltage output 3	Retransmission voltage output 3	Retransmission voltage output 3
DO1	9, 12	Alarm output 1	Alarm output 1	Alarm output 1	Alarm output 1
DO2	10, 12	Alarm output 2	Alarm output 2	Alarm output 2	Alarm output 2
DO3	11, 12	Alarm output 3	Alarm output 3	Alarm output 3	Alarm output 3
DO4	36, 40	Alarm output 4	Alarm output 4	Alarm output 4	Alarm output 4
DO5	37, 40	No function	No function	No function	No function
DO6	38, 40	No function	No function	No function	No function
DO7	39, 40	FAIL output	FAIL output	FAIL output	FAIL output
OUT1R	55 - 57	Control relay output (0, 3) Alarm output 4 (1, 2)	Heating control relay output (4) Alarm output 4 (5, 6)	Heating control relay output (7) Alarm output 4 (8, 9)	Heating control relay output (10) Alarm output 4 (11, 12)
OUT2R	58 - 60	Alarm output 3	Cooling control relay output	Alarm output 3	Alarm output 3

■ US1000-11: Loop control with Dual PV auto-selector (US mode 7)

Terminal Code	Terminal No.	Control Computation (MVS1 Set Value)			
		Time proportional PID (0, 1) Continuous PID (2) ON/OFF computation (3)	Heating/cooling computation (4 - 6)	Heating/cooling computation (7 - 9)	Heating/cooling computation (10 - 12)
AIN1	1 - 3	PV input 1	PV input 1	PV input 1	PV input 1
AIN2	46 - 48	Cascade input, feedforward input, or tracking input	Cascade input, feedforward input, or tracking input	Cascade input, feedforward input, or tracking input	Cascade input, feedforward input, or tracking input
AIN3	4, 5	PV input 2	PV input 2	PV input 2	PV input 2
DI1	6, 8	RUN/STOP switchover	RUN/STOP switchover	RUN/STOP switchover	RUN/STOP switchover
DI2	7, 8	MAN mode selection	MAN mode selection	MAN mode selection	MAN mode selection
DI3	31, 8	AUTO mode selection	AUTO mode selection	AUTO mode selection	AUTO mode selection
DI4	32, 8	Bit-0 of SV No. setting	Bit-0 of SV No. setting	Bit-0 of SV No. setting	Bit-0 of SV No. setting
DI5	33, 8	Bit-1 of SV No. setting	Bit-1 of SV No. setting	Bit-1 of SV No. setting	Bit-1 of SV No. setting
DI6	34, 8	Bit-2 of SV No. setting	Bit-2 of SV No. setting	Bit-2 of SV No. setting	Bit-2 of SV No. setting
DI7	35, 8	Bit-3 of SV No. setting	Bit-3 of SV No. setting	Bit-3 of SV No. setting	Bit-3 of SV No. setting
LPS1	19, 20	Loop power supply for transmitter 1	Loop power supply for transmitter 1	Loop power supply for transmitter 1	Loop power supply for transmitter 1
LPS2	51, 52	Loop power supply for transmitter 2	Loop power supply for transmitter 2	Loop power supply for transmitter 2	Loop power supply for transmitter 2
OUT1A	16, 18	Retransmission output (0, 3) Voltage pulse output (1) Current output (2)	Retransmission output (4) Heating pulse output (5) Heating current output (6)	Retransmission output (7) Heating pulse output (8) Heating current output (9)	Retransmission output (10) Heating pulse output (11) Heating current output (12)
OUT2A	49, 50	Retransmission current output 2	Retransmission current output 2	Cooling pulse output	Cooling current output
OUT3A	17, 18	Retransmission voltage output 3	Retransmission voltage output 3	Retransmission voltage output 3	Retransmission voltage output 3
DO1	9, 12	Alarm output 1	Alarm output 1	Alarm output 1	Alarm output 1
DO2	10, 12	Alarm output 2	Alarm output 2	Alarm output 2	Alarm output 2
DO3	11, 12	Alarm output 3	Alarm output 3	Alarm output 3	Alarm output 3
DO4	36, 40	Alarm output 4	Alarm output 4	Alarm output 4	Alarm output 4
DO5	37, 40	No function	No function	No function	No function
DO6	38, 40	No function	No function	No function	No function
DO7	39, 40	FAIL output	FAIL output	FAIL output	FAIL output
OUT1R	55 - 57	Control relay output (0, 3) Alarm output 4 (1, 2)	Heating control relay output (4) Alarm output 4 (5, 6)	Heating control relay output (7) Alarm output 4 (8, 9)	Heating control relay output (10) Alarm output 4 (11, 12)
OUT2R	58 - 60	Alarm output 3	Cooling control relay output	Alarm output 3	Alarm output 3

■ US1000-11: Loop control with PV-hold function (US mode 8)

Terminal Code	Terminal No.	Control Computation (MVS1 Set Value)			
		Time proportional PID (0, 1) Continuous PID (2) ON/OFF computation (3)	Heating/cooling computation (4 - 6)	Heating/cooling computation (7 - 9)	Heating/cooling computation (10 - 12)
AIN1	1 - 3	PV input	PV input	PV input	PV input
AIN2	46 - 48	No function	No function	No function	No function
AIN3	4, 5	Cascade input, feedforward input, or tracking input	Cascade input, feedforward input, or tracking input	Cascade input, feedforward input, or tracking input	Cascade input, feedforward input, or tracking input
DI1	6, 8	RUN/STOP switchover	RUN/STOP switchover	RUN/STOP switchover	RUN/STOP switchover
DI2	7, 8	'PV-hold and MAN mode' or 'AUTO mode'	'PV-hold and MAN mode' or 'AUTO mode'	'PV-hold and MAN mode' or 'AUTO mode'	'PV-hold and MAN mode' or 'AUTO mode'
DI3	31, 8	CAS mode selection	CAS mode selection	CAS mode selection	CAS mode selection
DI4	32, 8	Bit-0 of SV No. setting	Bit-0 of SV No. setting	Bit-0 of SV No. setting	Bit-0 of SV No. setting
DI5	33, 8	Bit-1 of SV No. setting	Bit-1 of SV No. setting	Bit-1 of SV No. setting	Bit-1 of SV No. setting
DI6	34, 8	Bit-2 of SV No. setting	Bit-2 of SV No. setting	Bit-2 of SV No. setting	Bit-2 of SV No. setting
DI7	35, 8	Bit-3 of SV No. setting	Bit-3 of SV No. setting	Bit-3 of SV No. setting	Bit-3 of SV No. setting
LPS1	19, 20	Loop power supply for transmitter 1	Loop power supply for transmitter 1	Loop power supply for transmitter 1	Loop power supply for transmitter 1
LPS2	51, 52	Loop power supply for transmitter 2	Loop power supply for transmitter 2	Loop power supply for transmitter 2	Loop power supply for transmitter 2
OUT1A	16, 18	Retransmission output (0, 3) Voltage pulse output (1) Current output (2)	Retransmission output (4) Heating pulse output (5) Heating current output (6)	Retransmission output (7) Heating pulse output (8) Heating current output (9)	Retransmission output (10) Heating pulse output (11) Heating current output (12)
OUT2A	49, 50	Retransmission current output 2	Retransmission current output 2	Cooling pulse output	Cooling current output
OUT3A	17, 18	Retransmission voltage output 3	Retransmission voltage output 3	Retransmission voltage output 3	Retransmission voltage output 3
DO1	9, 12	Alarm output 1	Alarm output 1	Alarm output 1	Alarm output 1
DO2	10, 12	Alarm output 2	Alarm output 2	Alarm output 2	Alarm output 2
DO3	11, 12	Alarm output 3	Alarm output 3	Alarm output 3	Alarm output 3
DO4	36, 40	Alarm output 4	Alarm output 4	Alarm output 4	Alarm output 4
DO5	37, 40	No function	No function	No function	No function
DO6	38, 40	No function	No function	No function	No function
DO7	39, 40	FAIL output	FAIL output	FAIL output	FAIL output
OUT1R	55 - 57	Control relay output (0, 3) Alarm output 4 (1, 2)	Heating control relay output (4) Alarm output 4 (5, 6)	Heating control relay output (7) Alarm output 4 (8, 9)	Heating control relay output (10) Alarm output 4 (11, 12)
OUT2R	58 - 60	Alarm output 3	Cooling control relay output	Alarm output 3	Alarm output 3

■ US1000-11: Dual-loop control (US mode 11)

US1000-11: Temperature and humidity control (US mode 12)

Terminal Code	Terminal No.	Control Computation (Set Value for MVS1 and MVS2)		
		Time proportional PID (0, 1) Continuous PID (2) ON/OFF computation (3)	Heating/cooling computation (4, 5)	Heating/cooling computation (6, 7)
AIN1	1 - 3	Loop-1 PV input	Loop-1 PV input	Loop-1 PV input
AIN2	46 - 48	Loop-2 PV input	Loop-2 PV input	Loop-2 PV input
AIN3	4, 5	Cascade input, feedforward input, or tracking input	Cascade input, feedforward input, or tracking input	Cascade input, feedforward input, or tracking input
DI1	6, 8	RUN/STOP switchover	RUN/STOP switchover	RUN/STOP switchover
DI2	7, 8	Loop-2 MAN mode selection	Loop-2 MAN mode selection	Loop-2 MAN mode selection
DI3	31, 8	Loop-1 MAN mode selection	Loop-1 MAN mode selection	Loop-1 MAN mode selection
DI4	32, 8	Bit-0 of SV No. setting	Bit-0 of SV No. setting	Bit-0 of SV No. setting
DI5	33, 8	Bit-1 of SV No. setting	Bit-1 of SV No. setting	Bit-1 of SV No. setting
DI6	34, 8	Bit-2 of SV No. setting	Bit-2 of SV No. setting	Bit-2 of SV No. setting
DI7	35, 8	Bit-3 of SV No. setting	Bit-3 of SV No. setting	Bit-3 of SV No. setting
LPS1	19, 20	Loop power supply for transmitter 1	Loop power supply for transmitter 1	Loop power supply for transmitter 1
LPS2	51, 52	Loop power supply for transmitter 2	Loop power supply for transmitter 2	Loop power supply for transmitter 2
OUT1A	16, 18	Loop-1 Retransmission output 1 (0, 3) Voltage pulse output (1) Current output (2)	Loop-1 Heating pulse output (4) Cooling pulse output (5)	Loop-1 Heating current output (6) Cooling current output (7)
OUT2A	49, 50	Loop-2 Retransmission output 2 (0, 3) Voltage pulse output (1) Current output (2)	Loop-2 Heating pulse output (4) Cooling pulse output (5)	Loop-2 Heating current output (6) Cooling current output (7)
OUT3A	17, 18	Retransmission voltage output 3	Retransmission voltage output 3	Retransmission voltage output 3
DO1	9, 12	Alarm output 1	Alarm output 1	Alarm output 1
DO2	10, 12	Alarm output 2	Alarm output 2	Alarm output 2
DO3	11, 12	Alarm output 3	Alarm output 3	Alarm output 3
DO4	36, 40	Alarm output 4	Alarm output 4	Alarm output 4
DO5	37, 40	No function	No function	No function
DO6	38, 40	No function	No function	No function
DO7	39, 40	FAIL output	FAIL output	FAIL output
OUT1R	55 - 57	Loop-1 Control relay output (0, 3) Alarm output 4 (1, 2)	Loop-1 Cooling control relay output (4) Heating control relay output (5)	Loop-1 Cooling control relay output (6) Heating control relay output (7)
OUT2R	58 - 60	Loop-2 Control relay output (0, 3) Alarm output 4 (1, 2)	Loop-2 Cooling control relay output (4) Heating control relay output (5)	Loop-2 Cooling control relay output (6) Heating control relay output (7)

■ US1000-11: Cascade control with two universal inputs (US mode 13)

Terminal Code	Terminal No.	Control Computation (MVS2 Set Value)			
		Time proportional PID (0, 1) Continuous PID (2) ON/OFF computation (3)	Heating/cooling computation (4 - 6)	Heating/cooling computation (7 - 9)	Heating/cooling computation (10 - 12)
AIN1	1 - 3	PV input 1	PV input 1	PV input 1	PV input 1
AIN2	46 - 48	PV input 2	PV input 2	PV input 2	PV input 2
AIN3	4, 5	Cascade input or feedforward input	Cascade input or feedforward input	Cascade input or feedforward input	Cascade input or feedforward input
DI1	6, 8	RUN/STOP switchover	RUN/STOP switchover	RUN/STOP switchover	RUN/STOP switchover
DI2	7, 8	OPEN/CLOSE switchover	OPEN/CLOSE switchover	OPEN/CLOSE switchover	OPEN/CLOSE switchover
DI3	31, 8	MAN mode selection	MAN mode selection	MAN mode selection	MAN mode selection
DI4	32, 8	AUTO mode selection	AUTO mode selection	AUTO mode selection	AUTO mode selection
DI5	33, 8	CAS mode selection	CAS mode selection	CAS mode selection	CAS mode selection
DI6	34, 8	Message input	Message input	Message input	Message input
DI7	35, 8	No function	No function	No function	No function
LPS1	19, 20	Loop power supply for transmitter 1	Loop power supply for transmitter 1	Loop power supply for transmitter 1	Loop power supply for transmitter 1
LPS2	51, 52	Loop power supply for transmitter 2	Loop power supply for transmitter 2	Loop power supply for transmitter 2	Loop power supply for transmitter 2
OUT1A	16, 18	Retransmission output (0, 3) Voltage pulse output (1) Current output (2)	Retransmission output (4) Heating pulse output (5) Heating current output (6)	Retransmission output (7) Heating pulse output (8) Heating current output (9)	Retransmission output (10) Heating pulse output (11) Heating current output (12)
OUT2A	49, 50	Retransmission current output 2	Retransmission current output 2	Cooling pulse output	Cooling current output
OUT3A	17, 18	Retransmission voltage output 3	Retransmission voltage output 3	Retransmission voltage output 3	Retransmission voltage output 3
DO1	9, 12	Alarm output 1	Alarm output 1	Alarm output 1	Alarm output 1
DO2	10, 12	Alarm output 2	Alarm output 2	Alarm output 2	Alarm output 2
DO3	11, 12	Alarm output 3	Alarm output 3	Alarm output 3	Alarm output 3
DO4	36, 40	Alarm output 4	Alarm output 4	Alarm output 4	Alarm output 4
DO5	37, 40	No function	No function	No function	No function
DO6	38, 40	No function	No function	No function	No function
DO7	39, 40	FAIL output	FAIL output	FAIL output	FAIL output
OUT1R	55 - 57	Control relay output (0, 3) Alarm output 4 (1, 2)	Heating control relay output (4) Alarm output 4 (5, 6)	Heating control relay output (7) Alarm output 4 (8, 9)	Heating control relay output (10) Alarm output 4 (11, 12)
OUT2R	58 - 60	Alarm output 3	Cooling control relay output	Alarm output 3	Alarm output 3

■ US1000-11: Loop control with PV switching and two universal inputs (US mode 14)

Terminal Code	Terminal No.	Control Computation (MVS1 Set Value)			
		Time proportional PID (0, 1) Continuous PID (2) ON/OFF computation (3)	Heating/cooling computation (4 - 6)	Heating/cooling computation (7 - 9)	Heating/cooling computation (10 - 12)
AIN1	1 - 3	PV input 1	PV input 1	PV input 1	PV input 1
AIN2	46 - 48	PV input 2	PV input 2	PV input 2	PV input 2
AIN3	4, 5	Cascade input, feedforward input, or tracking input	Cascade input, feedforward input, or tracking input	Cascade input, feedforward input, or tracking input	Cascade input, feedforward input, or tracking input
DI1	6, 8	RUN/STOP switchover	RUN/STOP switchover	RUN/STOP switchover	RUN/STOP switchover
DI2	7, 8	Dual-PV switching	Dual-PV switching	Dual-PV switching	Dual-PV switching
DI3	31, 8	MAN mode selection	MAN mode selection	MAN mode selection	MAN mode selection
DI4	32, 8	Bit-0 of SV No. setting	Bit-0 of SV No. setting	Bit-0 of SV No. setting	Bit-0 of SV No. setting
DI5	33, 8	Bit-1 of SV No. setting	Bit-1 of SV No. setting	Bit-1 of SV No. setting	Bit-1 of SV No. setting
DI6	34, 8	Bit-2 of SV No. setting	Bit-2 of SV No. setting	Bit-2 of SV No. setting	Bit-2 of SV No. setting
DI7	35, 8	Bit-3 of SV No. setting	Bit-3 of SV No. setting	Bit-3 of SV No. setting	Bit-3 of SV No. setting
LPS1	19, 20	Loop power supply for transmitter 1	Loop power supply for transmitter 1	Loop power supply for transmitter 1	Loop power supply for transmitter 1
LPS2	51, 52	Loop power supply for transmitter 2	Loop power supply for transmitter 2	Loop power supply for transmitter 2	Loop power supply for transmitter 2
OUT1A	16, 18	Retransmission output (0, 3) Voltage pulse output (1) Current output (2)	Retransmission output (4) Heating pulse output (5) Heating current output (6)	Retransmission output (7) Heating pulse output (8) Heating current output (9)	Retransmission output (10) Heating pulse output (11) Heating current output (12)
OUT2A	49, 50	Retransmission current output 2	Retransmission current output 2	Cooling pulse output	Cooling current output
OUT3A	17, 18	Retransmission voltage output 3	Retransmission voltage output 3	Retransmission voltage output 3	Retransmission voltage output 3
DO1	9, 12	Alarm output 1	Alarm output 1	Alarm output 1	Alarm output 1
DO2	10, 12	Alarm output 2	Alarm output 2	Alarm output 2	Alarm output 2
DO3	11, 12	Alarm output 3	Alarm output 3	Alarm output 3	Alarm output 3
DO4	36, 40	Alarm output 4	Alarm output 4	Alarm output 4	Alarm output 4
DO5	37, 40	No function	No function	No function	No function
DO6	38, 40	No function	No function	No function	No function
DO7	39, 40	FAIL output	FAIL output	FAIL output	FAIL output
OUT1R	55 - 57	Control relay output (0, 3) Alarm output 4 (1, 2)	Heating control relay output (4) Alarm output 4 (5, 6)	Heating control relay output (7) Alarm output 4 (8, 9)	Heating control relay output (10) Alarm output 4 (11, 12)
OUT2R	58 - 60	Alarm output 3	Cooling control relay output	Alarm output 3	Alarm output 3

■ US1000-11: Loop control with PV auto-selector and two universal inputs (US mode 15)

Terminal Code	Terminal No.	Control Computation (MVS1 Set Value)			
		Time proportional PID (0, 1) Continuous PID (2) ON/OFF computation (3)	Heating/cooling computation (4 - 6)	Heating/cooling computation (7 - 9)	Heating/cooling computation (10 - 12)
AIN1	1 - 3	PV input 1	PV input 1	PV input 1	PV input 1
AIN2	46 - 48	PV input 2	PV input 2	PV input 2	PV input 2
AIN3	4, 5	PV input 3, cascade input, feedforward input, or tracking input	PV input 3, cascade input, feedforward input, or tracking input	PV input 3, cascade input, feedforward input, or tracking input	PV input 3, cascade input, feedforward input, or tracking input
DI1	6, 8	RUN/STOP switchover	RUN/STOP switchover	RUN/STOP switchover	RUN/STOP switchover
DI2	7, 8	MAN mode selection	MAN mode selection	MAN mode selection	MAN mode selection
DI3	31, 8	AUTO mode selection	AUTO mode selection	AUTO mode selection	AUTO mode selection
DI4	32, 8	Bit-0 of SV No. setting	Bit-0 of SV No. setting	Bit-0 of SV No. setting	Bit-0 of SV No. setting
DI5	33, 8	Bit-1 of SV No. setting	Bit-1 of SV No. setting	Bit-1 of SV No. setting	Bit-1 of SV No. setting
DI6	34, 8	Bit-2 of SV No. setting	Bit-2 of SV No. setting	Bit-2 of SV No. setting	Bit-2 of SV No. setting
DI7	35, 8	Bit-3 of SV No. setting	Bit-3 of SV No. setting	Bit-3 of SV No. setting	Bit-3 of SV No. setting
LPS1	19, 20	Loop power supply for transmitter 1	Loop power supply for transmitter 1	Loop power supply for transmitter 1	Loop power supply for transmitter 1
LPS2	51, 52	Loop power supply for transmitter 2	Loop power supply for transmitter 2	Loop power supply for transmitter 2	Loop power supply for transmitter 2
OUT1A	16, 18	Retransmission output (0, 3) Voltage pulse output (1) Current output (2)	Retransmission output (4) Heating pulse output (5) Heating current output (6)	Retransmission output (7) Heating pulse output (8) Heating current output (9)	Retransmission output (10) Heating pulse output (11) Heating current output (12)
OUT2A	49, 50	Retransmission current output 2	Retransmission current output 2	Cooling pulse output	Cooling current output
OUT3A	17, 18	Retransmission voltage output 3	Retransmission voltage output 3	Retransmission voltage output 3	Retransmission voltage output 3
DO1	9, 12	Alarm output 1	Alarm output 1	Alarm output 1	Alarm output 1
DO2	10, 12	Alarm output 2	Alarm output 2	Alarm output 2	Alarm output 2
DO3	11, 12	Alarm output 3	Alarm output 3	Alarm output 3	Alarm output 3
DO4	36, 40	Alarm output 4	Alarm output 4	Alarm output 4	Alarm output 4
DO5	37, 40	No function	No function	No function	No function
DO6	38, 40	No function	No function	No function	No function
DO7	39, 40	FAIL output	FAIL output	FAIL output	FAIL output
OUT1R	55 - 57	Control relay output (0, 3) Alarm output 4 (1, 2)	Heating control relay output (4) Alarm output 4 (5, 6)	Heating control relay output (7) Alarm output 4 (8, 9)	Heating control relay output (10) Alarm output 4 (11, 12)
OUT2R	58 - 60	Alarm output 3	Cooling control relay output	Alarm output 3	Alarm output 3

3.2.3 Terminal Assignment for US1000-21 (Position Proportional Type)

- **US1000-21: Single-loop control (US mode 1)**
- US1000-21: Cascade secondary-loop control (US mode 3)**
- US1000-21: Cascade control (US mode 4)**
- US1000-21: Loop control for backup (US mode 5)**

Terminal Code	Terminal No.	Controller mode (US mode)			
		US mode 1	US mode 3	US mode 4	US mode 5
AIN1	1 - 3	PV input	PV input	Primary-side PV input	PV input
AIN2	46 - 48	No function	Feedforward input	Cascade input or feedforward input	Cascade input or feedforward input
AIN3	4, 5	Cascade input or feedforward input	Cascade input	Secondary-side PV input	Tracking switching
DI1	6, 8	RUN/STOP switchover	RUN/STOP switchover	RUN/STOP switchover	RUN/STOP switchover
DI2	7, 8	MAN mode selection	CAS → AUTO mode when the contact is off	OPEN/CLOSE switchover	Tracking input
DI3	31, 8	AUTO mode selection	MAN mode selection	MAN mode selection	MAN mode selection
DI4	32, 8	Bit-0 of SV No. setting	AUTO mode selection	AUTO mode selection	Bit-0 of SV No. setting
DI5	33, 8	Bit-1 of SV No. setting	CAS mode selection	CAS mode selection	Bit-1 of SV No. setting
DI6	34, 8	Bit-2 of SV No. setting	Message input	Message input	Bit-2 of SV No. setting
DI7	35, 8	Bit-3 of SV No. setting	No function	No function	Bit-3 of SV No. setting
LPS1	19, 20	Loop power supply for transmitter 1	Loop power supply for transmitter 1	Loop power supply for transmitter 1	Loop power supply for transmitter 1
LPS2	51, 52	Loop power supply for transmitter 2	Loop power supply for transmitter 2	Loop power supply for transmitter 2	Loop power supply for transmitter 2
OUT1A	16, 18	Retransmission output 1	Retransmission output 1	Retransmission output 1	Retransmission output 1
OUT2A	49, 50	Retransmission current output 2	Retransmission current output 2	Retransmission current output 2	Retransmission current output 2
OUT3A	17, 18	Retransmission voltage output 3	Retransmission voltage output 3	Retransmission voltage output 3	Retransmission voltage output 3
DO1	9, 12	Alarm output 1	Alarm output 1	Alarm output 1	Alarm output 1
DO2	10, 12	Alarm output 2	Alarm output 2	Alarm output 2	Alarm output 2
DO3	11, 12	Alarm output 3	CAS output	Alarm output 3	Error output
DO4	36, 40	Alarm output 4	Alarm output 4	Alarm output 4	Alarm output 4
DO5	37, 40	No function	Alarm output 3	No function	Alarm output 3
DO6	38, 40	No function	No function	No function	No function
DO7	39, 40	FAIL output	FAIL output	FAIL output	FAIL output
FBIN	55 - 57	Valve position feedback input	Valve position feedback input	Valve position feedback input	Valve position feedback input
OUTR	58 - 60	Position proportional control relay output	Position proportional control relay output	Position proportional control relay output	Position proportional control relay output

- **US1000-21: Loop control with PV switching (US mode 6)**
- US1000-21: Loop control with PV auto-selector (US mode 7)**
- US1000-21: Loop control with PV-hold function (US mode 8)**
- US1000-21: Cascade control with two universal inputs (US mode 13)**

Terminal Code	Terminal No.	Controller mode (US mode)			
		US mode 6	US mode 7	US mode 8	US mode 13
AIN1	1 - 3	PV input 1	PV input 1	PV input	PV input 1
AIN2	46 - 48	Cascade input, feedforward input, or tracking input	Cascade input, feedforward input, or tracking input	No function	PV input 2
AIN3	4, 5	PV input 2	PV input 2	Cascade input, feedforward input, or tracking input	Cascade input or feedforward input
DI1	6, 8	RUN/STOP switchover	RUN/STOP switchover	RUN/STOP switchover	RUN/STOP switchover
DI2	7, 8	Dual-PV switching	MAN mode selection	'PV-hold and MAN mode' or 'AUTO mode'	OPEN/CLOSE switchover
DI3	31, 8	MAN mode selection	AUTO mode selection	CAS mode selection	MAN mode selection
DI4	32, 8	Bit-0 of SV No. setting	Bit-0 of SV No. setting	Bit-0 of SV No. setting	AUTO mode selection
DI5	33, 8	Bit-1 of SV No. setting	Bit-1 of SV No. setting	Bit-1 of SV No. setting	CAS mode selection
DI6	34, 8	Bit-2 of SV No. setting	Bit-2 of SV No. setting	Bit-2 of SV No. setting	Message input
DI7	35, 8	Bit-3 of SV No. setting	Bit-3 of SV No. setting	Bit-3 of SV No. setting	No function
LPS1	19, 20	Loop power supply for transmitter 1	Loop power supply for transmitter 1	Loop power supply for transmitter 1	Loop power supply for transmitter 1
LPS2	51, 52	Loop power supply for transmitter 2	Loop power supply for transmitter 2	Loop power supply for transmitter 2	Loop power supply for transmitter 2
OUT1A	16, 18	Retransmission output 1	Retransmission output 1	Retransmission output 1	Retransmission output 1
OUT2A	49, 50	Retransmission current output 2	Retransmission current output 2	Retransmission current output 2	Retransmission current output 2
OUT3A	17, 18	Retransmission voltage output 3	Retransmission voltage output 3	Retransmission voltage output 3	Retransmission voltage output 3
DO1	9, 12	Alarm output 1	Alarm output 1	Alarm output 1	Alarm output 1
DO2	10, 12	Alarm output 2	Alarm output 2	Alarm output 2	Alarm output 2
DO3	11, 12	Alarm output 3	Alarm output 3	Alarm output 3	Alarm output 3
DO4	36, 40	Alarm output 4	Alarm output 4	Alarm output 4	Alarm output 4
DO5	37, 40	No function	No function	No function	No function
DO6	38, 40	No function	No function	No function	No function
DO7	39, 40	FAIL output	FAIL output	FAIL output	FAIL output
FBIN	55 - 57	Valve position feedback input	Valve position feedback input	Valve position feedback input	Valve position feedback input
OUTR	58 - 60	Position proportional control relay output	Position proportional control relay output	Position proportional control relay output	Position proportional control relay output

■ **US1000-21: Loop control with PV switching and two universal inputs (US mode 14)**

US1000-21: Loop control with PV auto-selector and two universal inputs (US mode 15)

Terminal Code	Terminal No.	Controller mode (US mode)	
		US mode 14	US mode 15
AIN1	1 - 3	PV input 1	PV input 1
AIN2	46 - 48	PV input 2	PV input 2
AIN3	4, 5	Cascade input, feedforward input, or tracking input	PV input 3, cascade input, feedforward input, or tracking input
DI1	6, 8	RUN/STOP switchover	RUN/STOP switchover
DI2	7, 8	Dual-PV switching	MAN mode selection
DI3	31, 8	MAN mode selection	AUTO mode selection
DI4	32, 8	Bit-0 of SV No. setting	Bit-0 of SV No. setting
DI5	33, 8	Bit-1 of SV No. setting	Bit-1 of SV No. setting
DI6	34, 8	Bit-2 of SV No. setting	Bit-2 of SV No. setting
DI7	35, 8	Bit-3 of SV No. setting	Bit-3 of SV No. setting
LPS1	19, 20	Loop power supply for transmitter 1	Loop power supply for transmitter 1
LPS2	51, 52	Loop power supply for transmitter 2	Loop power supply for transmitter 2
OUT1A	16, 18	Retransmission output 1	Retransmission output 1
OUT2A	49, 50	Retransmission current output 2	Retransmission current output 2
OUT3A	17, 18	Retransmission voltage output 3	Retransmission voltage output 3
DO1	9, 12	Alarm output 1	Alarm output 1
DO2	10, 12	Alarm output 2	Alarm output 2
DO3	11, 12	Alarm output 3	Alarm output 3
DO4	36, 40	Alarm output 4	Alarm output 4
DO5	37, 40	No function	No function
DO6	38, 40	No function	No function
DO7	39, 40	FAIL output	FAIL output
FBIN	55 - 57	Valve position feedback input	Valve position feedback input
OUTR	58 - 60	Position proportional control relay output	Position proportional control relay output

4. Setting the Basic Functions

This chapter describes the setting procedure and the meanings of the parameters used to select and adjust the US1000 controller functions.

The parameters of the US1000 controller are largely divided into two types: “operation parameters” and “setup parameters.”

- Operation parameters are the parameters that are changed relatively often during operation.
- Setup parameters are the parameters that determine the controller functions and are rarely changed once they have been set.

Some parameters must be set before operation (such as the controller mode (US mode) and the input type), while others can be set as necessary according to the user’s needs. This chapter describes the setting procedure for parameters that must be set and those that are used often. Refer to the parameter lists in Appendixes 3 and 4, and the parameter maps in Appendix 5 to set the other parameters.

4.1 Example of Parameter Display

To set an operation parameter or setup parameter, first call up the main menu to which the parameter belongs. Then, from the main menu, call up the submenu which contains the parameter, and then the target parameter from that submenu.

Appendix 5 shows the locations of all of the main menus, submenus, and parameters to help you call up parameters.

● Examples of parameter display

When a main menu is displayed, the top bar flashes slowly.

This decimal point flashes on loop-2 menus.

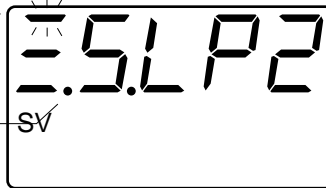

Example of a main menu display
(Loop-2 setup menu)

When a submenu is displayed, the middle bar flashes slowly.

This decimal point flashes on loop-2 submenus.

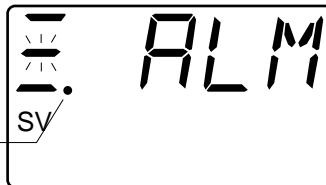

Example of a submenu display
(Alarm setting submenu)

When a parameter is displayed, the bottom bar flashes slowly.

This decimal point flashes on loop-2 parameter displays.

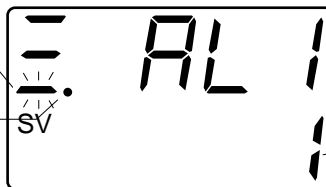

Example of a parameter display
(Alarm 1 type)

4.2 Procedure for Setting the Basic Functions

Always set the US1000 controller functions following the procedure below. Changing the controller mode and input/output settings will initialize the related parameters depending on the change.

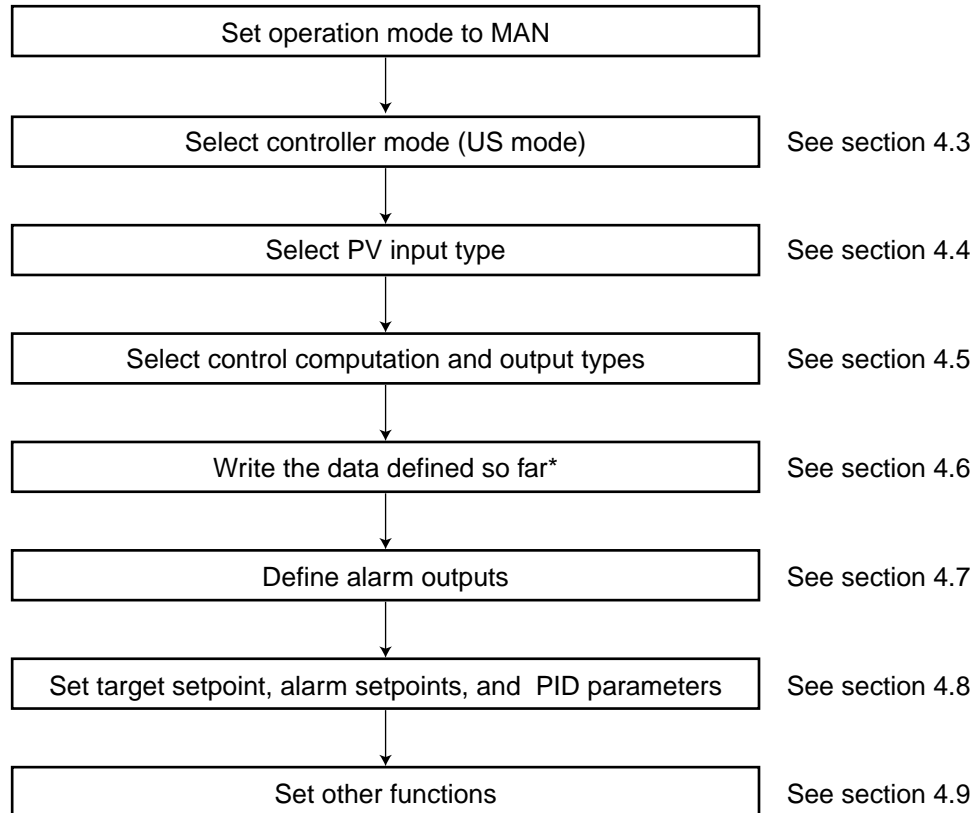

* This initializes the related parameters according to the controller mode (US mode) and PV input type.

■ Switching the Operation Mode

Before starting to setup the functions, press **(M)** key and change the operation mode to MAN. Setup parameters can only be set in MAN mode. Change both loop-1 and loop-2's operation mode to MAN when the controller mode (US mode) is dual-loop control or temperature and humidity control.

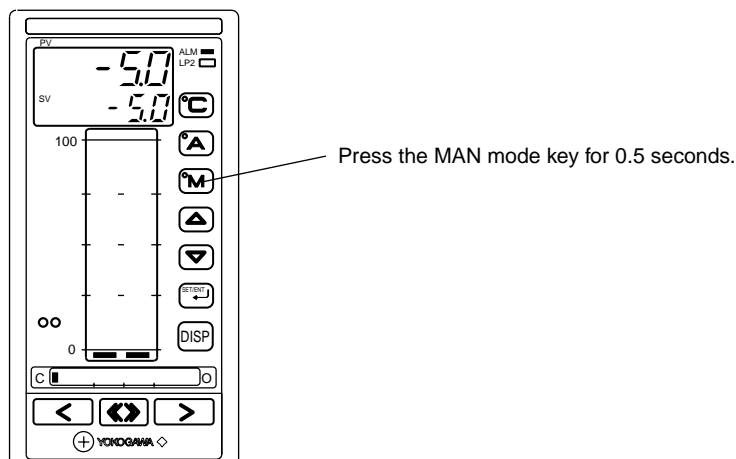

4.3 Selecting the Controller Mode (US Mode)

The controller mode (US mode) determines the basic action of the controller. The US1000 controller has 14 selectable controller modes.



NOTE

- Since changing the controller mode resets the internal functions of the controller and initializes the related parameters accordingly, be sure to set the controller mode before setting other parameters.
- Some controller modes cannot be selected depending on the model and suffix codes of the US1000 controller.

US1000-00: Modes that cannot be selected include dual-loop control, temperature and humidity control, cascade control with two universal inputs, loop control with PV switching or PV auto-selector and two universal inputs, and custom computation control.

US1000-21: Modes that cannot be selected include cascade primary-loop control, dual-loop control, and temperature and humidity control.

■ Controller Mode (US Mode)

Controller mode	Setting	Description	Model: US1000		
			-00	-11	-21
Single-loop control	1	Basic PID control			
Cascade primary-loop control	2	Operates as a primary controller in cascade control.			NA
Cascade secondary-loop control	3	Operates as a secondary controller in cascade control.			
Cascade control	4	Performs cascade control with a single controller.			
Loop control for backup	5	PID control with backup function for the supervisory system.			
Loop control with PV switching	6	PID control with dual-PV switching function by contact input or PV range.			
Loop control with PV auto-selector	7	PID control with dual-PV auto-selector function by minimum/maximum/average/difference.			
Loop control with PV-hold function	8	PID control with a PV- and MV-hold function.			
Dual-loop control	11	Basic PID control for independent two loops.	NA		NA
Temperature and humidity control	12	Controls temperature and relative humidity independently by PID control.	NA		NA
Cascade control with two universal inputs	13	Performs cascade control using two universal inputs.	NA		
Loop control with PV switching and two universal inputs	14	Performs loop control with PV switching using two universal inputs.	NA		
Loop control with PV auto-selector and two universal inputs	15	Performs loop control with PV auto-selector using two universal inputs.	NA		
Custom computation control	21	Controls by user-defined control and computation functions.	NA		

NA: Not available



See Also

Block diagram for each controller mode is given in the appendix of the separate 'US1000 Digital Indicating Controller Functions (IM 5D1A01-02E)' manual.



■ Parameter to Set Controller Mode (US Mode)

Main menu	Submenu	Parameter	Description	Setting range	Default
USMD	MD	USM	Controller mode (US mode)	See the table on the previous page.	1

■ Setting the Controller Mode (US Mode)

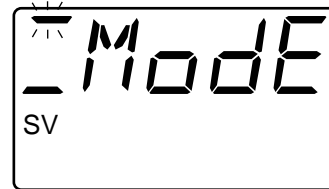
1. Press the  key for 3 seconds from an operation display to call up the mode menu (MODE) or loop-1 operation menu (O.LP1). (O.LP1 is displayed for the default setting.)



2. Press the  key once to call up the setup menu (STUP). Press the  key. If a password has been set, input the password here.

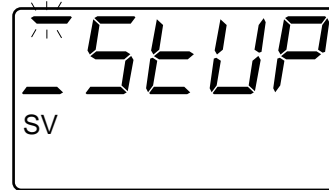

3. The loop-1 setup menu (S.LP1) is then displayed. Press the  key once to call up the controller function setup menu (USMD).





4. Press the  key to call up the controller mode submenu (MD).



5. Press the  key to display the controller mode (US mode) parameter (USM).



6. Select the controller mode (US mode) value using the  and  keys. (For example, select 4 for cascade control.) A decimal point appears and flashes. Some controller modes cannot be used depending on the model and suffix code, in which case their controller mode values will not be displayed.

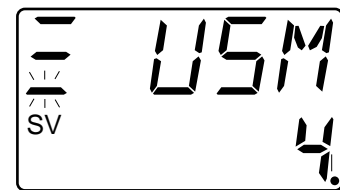

7. Press the  key. The display is cleared for a moment and the controller's internal functions are reset.



8. An operation display then appears.



4.4 Selecting the PV Input Type

The US1000 controller supports universal inputs and can receive the signals from a thermocouple and RTD, and from standard signals and DC voltage signals, as PV inputs. Up to 3 inputs are available depending on the model and suffix code, and you can set the input type and range for each input.

■ Analog Input Terminals of the US1000 Controller

The US1000 controller has a maximum of 3 analog input terminals. The AIN1, AIN2, and AIN3 terminals correspond to analog inputs 1, 2, and 3, respectively. In this section, the procedure to set analog input 1 is described. If you are also using analog input 2 and/or 3, set them in the same manner.

- AIN1 terminal: Universal analog input terminal used for a PV input.
- AIN2 terminal: Universal analog input terminal. This terminal is not provided on the US1000-00 model (which only has AIN1 and AIN3 terminals).
- AIN3 terminal: Analog input terminal for voltage input and used for cascade input etc..



TIP

- Signals assigned to the analog input terminals

Setting the controller mode (US mode) automatically sets the input signals used in that controller mode, such as the PV input, cascade input, feedforward input, tracking input, etc., to the AIN1, AIN2, and AIN3 terminals.



See Also

Section 3.2, “Signals Assigned to Terminals,” for the signal assignment of the analog input terminals.

In this section, the procedure to set the type-J thermocouple and a measurement range of 0 to 500°C for the AIN1 signal is described as an example.

■ Input Types and Ranges of Universal Inputs



















Input type		Setting	Range (°C)	Range (°F)	Accuracy
Thermocouple	K	1	-270.0 to 1370.0°C	-450.0 to 2500.0°F	0°C and over: ±0.1% of F.S.
		2	-270.0 to 1000.0°C	-450.0 to 2300.0°F	Below 0°C : ±0.2% of F.S.
		3	-200.0 to 500.0°C	-200.0 to 1000.0°F	K (below -200°C) : ±2% of F.S.
	J	4	-200.0 to 1200.0°C	-300.0 to 2300.0°F	T (below -200°C) : ±1% of F.S.
	T	5	-270.0 to 400.0°C	-450.0 to 750.0°F	
		6	0.0 to 400.0°C	-200.0 to 750.0°F	
	B	7	0.0 to 1800.0°C	32 to 3300°F	400°C and over: ±0.1% of F.S. Below 400°C : ±5% of F.S.
	S	8	0.0 to 1700.0°C	32 to 3100°F	±0.15% of F.S.
	R	9	0.0 to 1700.0°C	32 to 3100°F	
	N	10	-200.0 to 1300.0°C	-300.0 to 2400.0°F	±0.1% of F.S.
	E	11	-270.0 to 1000.0°C	-450.0 to 1800.0°F	0°C and over: ±0.1% of F.S.
	L	12	-200.0 to 900.0°C	-300.0 to 1600.0°F	Below 0°C : ±0.2% of F.S.
			0.0 to 400.0°C	-200.0 to 1000.0°F	E (below -200°C) : ±1.5% of F.S.
	U	13	-200.0 to 400.0°C	-300.0 to 750.0°F	±0.2% of F.S.
			0.0 to 400.0°C	-200.0 to 1000.0°F	
	W	15	0.0 to 2300.0°C	32 to 4200°F	±0.2% of F.S.
	Platinel 2	16	0.0 to 1390.0°C	32.0 to 2500.0°F	±0.1% of F.S.
	PR20-40	17	0.0 to 1900.0°C	32 to 3400°F	800°C and over: ±0.5% of F.S. Below 800°C : Accuracy not guaranteed
W97Re3 W75Re25	18	0.0 to 2000.0°C	32 to 3600°F	±0.2% of F.S.	
RTD	JPt100	30	-200.0 to 500.0°C	-300.0 to 1000.0°F	±0.1% of F.S.
		31	-150.00 to 150.00°C	-200.0 to 300.0°F	±0.2% of F.S.
	Pt100 (ITS90)	35	-200.0 to 850.0°C	-300.0 to 1560.0°F	±0.1% of F.S.
		36	-200.0 to 500.0°C	-300.0 to 1000.0°F	
		37	-150.00 to 150.00°C	-200.0 to 300.0°F	±0.2% of F.S.
Standard signal	0.4 to 2.0 V	40	0.400 to 2.000	/	±0.1% of F.S.
	1 to 5 V	41	1.000 to 5.000		
DC voltage	0 to 2 V	50	0.000 to 2.000		
	0 to 10 V	51	0.00 to 10.00		
	-10 to 20mV	55	-10.00 to 20.00		
	0 to 100mV	56	0.0 to 100.0		

* Performance under standard operating conditions (temperature: 23 ±2°C; humidity: 55 ±10% RH; power supply frequency: 50/60 Hz).

■ Parameters to Set the PV Input Type

Main menu	Submenu	Parameter	Description	Setting Range	Default
USMD	IN	TYP1	Analog input-1 type for AIN1 terminal	See the table above	1
		UNI1	Analog input-1 unit	°C: Celsius; °F: Fahrenheit	°C
		RH1	Maximum value of analog input-1 range	Within instrument input range	Maximum level of instrument range
		RL1	Minimum value of analog input-1 range	Within instrument input range	Minimum level of instrument range

■ Setting the PV Input Type

1. Follow steps 1 to 3 of the controller mode (US mode) setting procedure in the previous section to call up the display shown on the right.
2. Press the  key once to call up the controller mode submenu (MD).
3. Press the  key once to call up the analog input submenu (IN).
4. Press the  key to display the analog input-1 type parameter (TYP1). (For example, select 4 for the type-J thermocouple.) Select the analog input-1 type value using the  and  keys. A decimal point appears and flashes when the setting is changed.
5. Press the  key to register the change. The decimal point disappears.
6. Press the  key to display the analog input-1 unit parameter (UNI1). Select the analog input-1 unit using the  and  keys, and press the  key to register the setting.
7. Press the  key to display the maximum value of the analog input-1 range parameter (RH1). Display the maximum value of the range you want to set using the  and  keys, and press the  key to register the setting.
8. Press the  key to display the minimum value of the analog input-1 range parameter (RL1). Display the minimum value of the range you want to set using the  and  keys, and press the  key to register the setting.
9. Press the  key twice to return to the controller function setup menu (USMD).

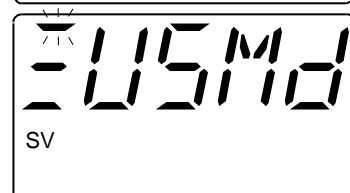
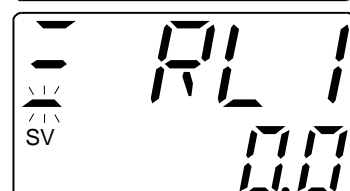
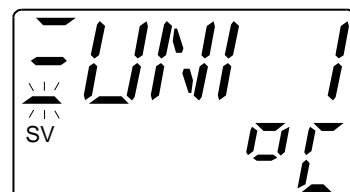
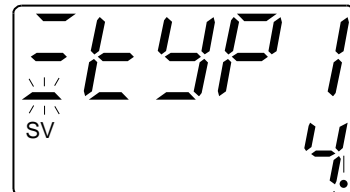
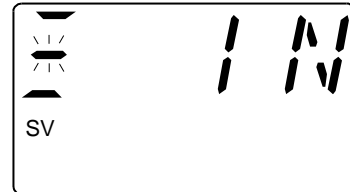
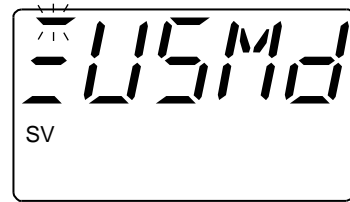

4.5 Selecting the Control Computation and Output Types

You can select the type of control computation for each control loop.

Normally, there is a single control loop. In the controller mode (US mode) for “dual-loop control” and “temperature and humidity control”, however, the US1000 controller has two control loops and a control computation type must be selected for each loop.

The types of control computation are listed in the table below. Each control computation has a specific output type. The control computation for the US1000-21 model is fixed at position proportional PID and cannot be changed.



NOTE

Some control computation types cannot be selected depending on the US1000 model and suffix code.

US1000-00: Only “time proportional PID computation with voltage pulse output” and “continuous PID computation” can be selected.

US1000-11: All types except for “position proportional PID computation” can be selected.

US1000-21: Only “position proportional PID computation” can be selected. It cannot be changed.

■ Control Computation Types

Control computation type	Setting	Description	Output type
Time proportional PID computation with relay output	0	Outputs the PID computation results as a pulse width of the time proportional on/off signal.	Control relay output
Time proportional PID computation with voltage pulse output	1	Outputs the PID computation results as a pulse width of the time proportional on/off signal.	Voltage pulse output
Continuous PID computation	2	Outputs the PID computation result as an analog signal.	Current output
On/off computation	3	Compares the SV and PV and outputs the on/off signal depending on whether it is a positive or negative deviation.	Control relay output
Heating/cooling computation (See below)	4 to 12	Outputs the PID or on/off computation result as two signals — one for heating and the other for cooling.	Either a control relay, voltage pulse, or current output can be selected for each of the heating-side and cooling-side outputs.
Position proportional PID computation	None	Controls so that the output and control valve opening are always compatible.	Position proportional control relay output

4: Heating control relay output • Cooling control relay output

5: Heating pulse output • Cooling control relay output

6: Heating current output • Cooling control relay output

7: Heating control relay output • Cooling pulse output

8: Heating pulse output • Cooling pulse output

9: Heating current output • Cooling pulse output

10: Heating control relay output • Cooling current output

11: Heating pulse output • Cooling current output

12: Heating current output • Cooling current output

For dual-loop control and temperature and humidity control, both loop-1 and loop-2 have the same output combination :

4: Heating pulse output • Cooling control relay output

5: Heating control relay output • Cooling pulse output

6: Heating current output • Cooling control relay output

7: Heating control relay output • Cooling current output

■ Parameters to Set the Control Computation Type

Main menu	Submenu	Parameter	Description	Setting Range	Default
USMD	OUT	MVS1	MV1 selection	0: Control relay output, 1: Voltage pulse output, 2: Current output, 3: Control relay output for ON/OFF computation, 4 to 12: Output for heating/cooling computation	2
		MVS2	MV2 selection		2



TIP

Either MVS1 or MVS2 will be displayed according to the controller mode (US mode). Set the displayed parameter.

Set both for dual-loop control and temperature and humidity control.

■ Setting the Control Computation Type

1. This display represents the last step of the PV input type setting procedure of the previous section.

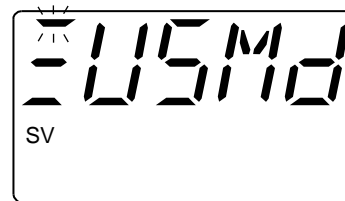



2. Press the  key once to call up the controller mode submenu (MD).

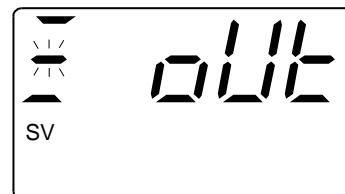

3. Press the  key twice to call up the MV output submenu (OUT).



4. Press the  key to display the MV1 selection parameter (MVS1). Select the MV output type using the  and  keys. (For example, select 1 for time proportional PID computation with voltage pulse output.) A decimal point appears and flashes when the setting is changed.

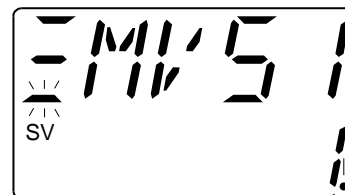

5. Press the  key to register the setting. The decimal point disappears.

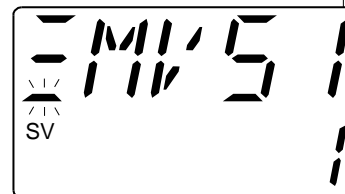

6. Press the  key twice to return to the controller function setup menu (USMD).

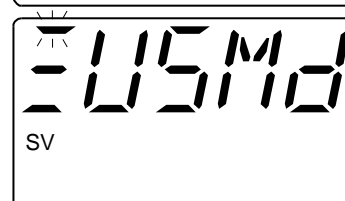

4.6 Writing the Data Defined So Far (Parameter Initialization)

Once you have reached this point, you need to write the information that you have defined so far (controller mode, PV input, and control computation) into the controller and initialize the related parameters.

■ Parameter for Initializing Parameters

Main menu	Submenu	Parameter	Description	Setting Range	Default
USMD	INIT	INIT	Parameter initialization	OFF, ON	OFF

■ Initializing Parameters

1. This display represents the last step of the control computation setting procedure of the previous section.



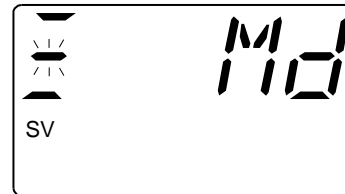

2. Press the  key once to call up the controller mode submenu (MD).

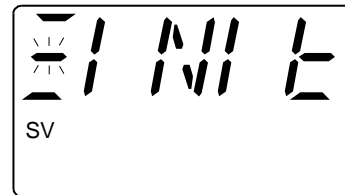

3. Press the  key several times to call up the parameter initialization submenu (INIT).



4. Press the  key to display the parameter initialization parameter (INIT). Select "ON" using the  key. A decimal point appears and flashes when the setting is changed.

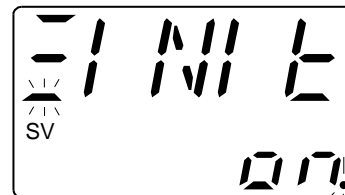

5. Press the  key to register the setting. The decimal point disappears.

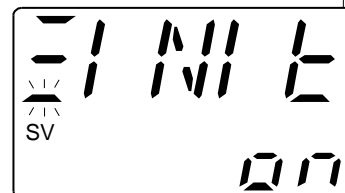

6. Press the  key twice to return to the controller function setup menu (USMD).

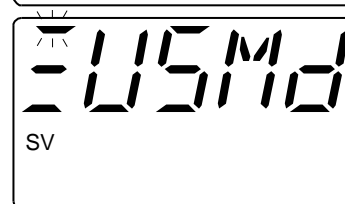

4.7 Defining the Alarm Outputs (as necessary)

The alarm outputs are pre-assigned to the US1000 controller's contact output terminals. For example, the US1000-00 (basic type) set up for single-loop control (US mode = 1) assigns alarm output 1, alarm output 2 and alarm output 3 to DO1 (terminal nos. 9 and 12), DO2 (terminal nos. 10 and 12) and DO3 (terminal nos. 11 and 12), respectively. Refer to section 3.2 for the assignments of the other controller modes.

Any one of the alarms listed in the table below can be assigned to each alarm output.

Alarm type	Setting	Alarm type	Setting
PV high limit	1	PV high limit with waiting action	11
PV low limit	2	PV low limit with waiting action	12
High limit deviation	3	High limit deviation with waiting action	13
Low limit deviation	4	Low limit deviation with waiting action	14
Deviation of high limit passive	5	Deviation of high limit passive with waiting action	15
Deviation of low limit passive	6	Deviation of low limit passive with waiting action	16
Deviation of high and low limits	7	Deviation of high and low limits with waiting action	17
Deviation within high and low limits	8	Deviation within high and low limits with waiting action	18
PV high limit passive	9	PV high limit passive with waiting action	19
PV low limit passive	10	PV low limit passive with waiting action	20

Alarm type	Setting
SV high limit	21
SV low limit	22
MV high limit	23
MV low limit	24
PV velocity alarm	25
PV velocity alarm passive	26
Self-diagnostic alarm	27
Self-diagnostic alarm passive	28
FAIL passive	29



TIP

- The passive alarm turns the contact ON when normal, and OFF when the alarm occurs.
- The waiting action suppresses the alarm during the period from when control is started until it stabilizes.



See Also













- Section 3.2, "Signals Assigned to Terminals," to find the terminal to which the alarm output is assigned.
- See section 3.14, "Parameters for Alarm Output" of the separate 'US1000 Digital Indicating Controller Functions' manual, for detailed information on the alarm actions.

■ Parameters for Defining the Alarm Outputs

Main menu	Submenu	Parameter	Description	Setting Range	Default
S.LP1 S.LP2	ALM	AL1	Alarm 1 type	OFF, 1 to 29 (see the previous page)	1
		AL2	Alarm 2 type	OFF, 1 to 29 (see the previous page)	2
		AL3	Alarm 3 type	OFF, 1 to 29 (see the previous page)	1
		AL4	Alarm 4 type	OFF, 1 to 29 (see the previous page)	2

After setting the controller mode (US mode) for dual-loop control or temperature and humidity control, also set the loop-2 alarm outputs. (These parameter settings are located under the “S.LP2” setup parameter main menu.)

■ Defining Alarm Outputs

1. This display represents the last step of the parameter initializing procedure of the previous section.
2. Press the  key once to call up the loop-1 setup menu (S.LP1).
3. Press the  key once to call up the target setpoint submenu (SV).
4. Press the  key once to call up the alarm setting submenu (ALM).
5. Press the  key to display the alarm-1 type parameter (AL1). Select the alarm type you want to set using the  and  keys. (For example, select 9 for PV high limit passive.) A decimal point appears and flashes when the setting is changed.
6. Press the  key to register the setting. The decimal point disappears.
7. Press the  key. If AL2 and the parameters of other alarm types are required, also set these in the same manner (that is, select the value you want to set using the  and  keys, and press the  key twice).
8. Press the  key twice to return to the controller function setup menu (USMD).

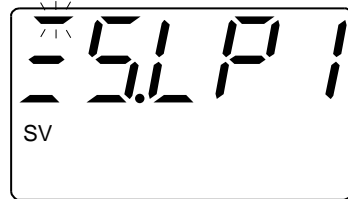
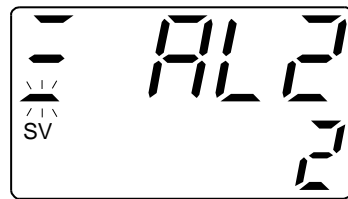
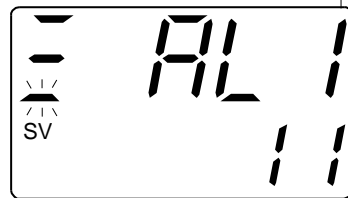
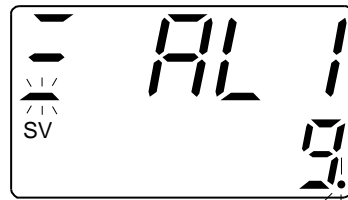
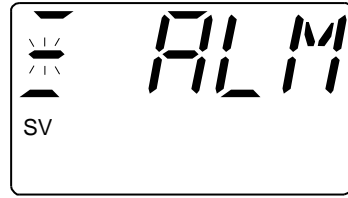
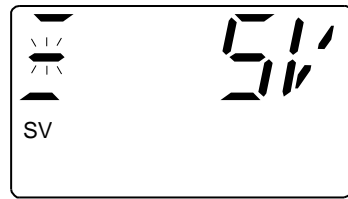
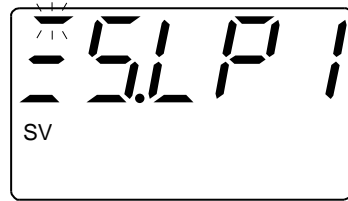
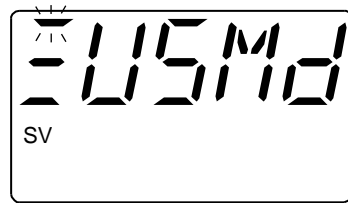

4.8 Setting the Target Setpoint, Alarm Setpoints, and PID Parameters

The basic operation parameters should be pre-set. You can change the settings of these parameters after the start of operation.

■ Parameters to Set Target Setpoint, Alarm Setpoints, and PID Parameters

Main menu	Submenu	Parameter	Description	Setting Range	Default
O.LP1 O.LP2	1.PID	1.SV	Target setpoint	EU (0.0 to 100.0%)	EU (0%)
		1.A1	Alarm 1 setpoint	PV alarm: EU (-100.0 to 100.0%) Deviation alarm/PV-velocity alarm: EUS(-100.0 to 100.0%) SV alarm: EU (0.0 to 100.0%) MV alarm: -5.0 to 105.0%	PV high limit: EU (100.0%)
		1.A2	Alarm 2 setpoint		Deviation alarm: EUS (0.0%)
		1.A3	Alarm 3 setpoint		MV high limit: 100.0%
		1.A4	Alarm 4 setpoint		MV low limit: 0.0%
		1.P	Proportional band	0.1 to 999.9%, 0.0 to 999.9% for heating/cooling computation	PV velocity: EUS (100.0%)
		1.I	Integral time	OFF, 1 to 6000 sec.	Other alarms: EU (0.0%)
		1.D	Derivative time	OFF, 1 to 6000 sec.	999.9%
				1000 sec.	
				OFF	OFF

EU is the engineering unit corresponding to the instrument range; EUS is the engineering unit corresponding to the span of the instrument range. See Appendix 2 for further explanation.

If you use loop-2, you must also set the parameters for loop-2. (Set the parameters listed under the “O.LP2” operation parameter main menu.)

■ Setting the Target Setpoint, Alarm Setpoints, and PID Parameters

1. This display represents the last step of the alarm output defining procedure in the previous section.

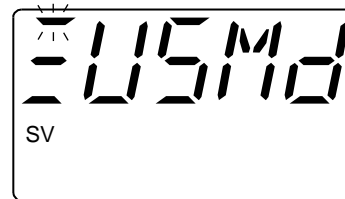

2. Press the **DISP** key once. When the mode menu (MODE) is displayed, press the **Δ** key once to call up the loop-1 operation menu (O.LP1).

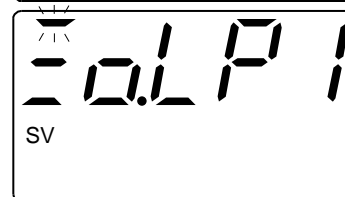



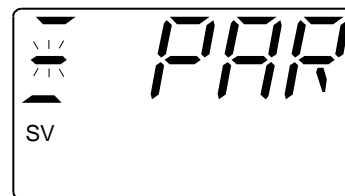



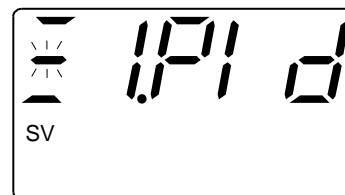





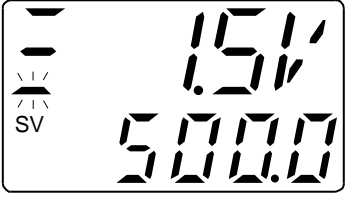



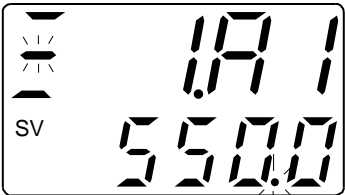

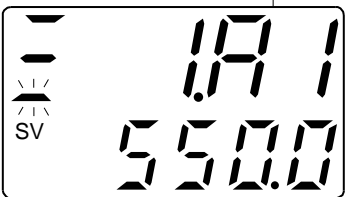





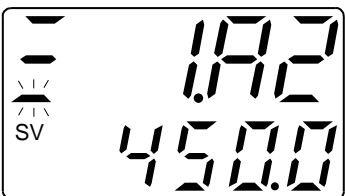

3. Press the **SETENT** key once to call up the computation parameter submenu (PAR).

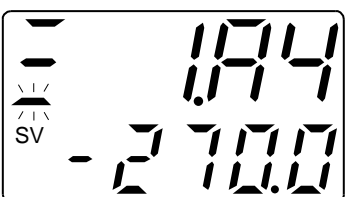

4. Press the **Δ** key once to call up the 1.PID submenu (1.PID).

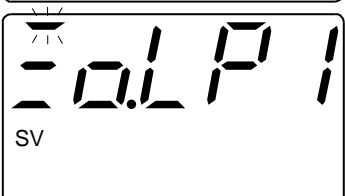

5. Press the  key once to display the target setpoint parameter (1.SV). Set the target setpoint value you want to set using the  and  keys. The decimal point flashes.
 
6. Press the  key to register the setting. The decimal point stops flashing.
 
7. Press the  key to display the alarm-1 setpoint parameter (1.A1). This is the alarm setpoint that corresponds to the “alarm-1 type” set in the previous section. Set the alarm setpoint value you want to set using the  and  keys. The decimal point flashes.
 
8. Press the  key to register the setting. The decimal point stops flashing.
 
9. Press the  key to display the alarm-2 setpoint parameter (1.A2). Set it in the same manner as 1.A1 (that is, select the value you want to set using the  and  keys, and press the  key twice). If you do not need to make a setting, just press the  key.
 
10. Set 1.A3 and 1.A4 in the same manner (that is, select the value you want to set using the  and  keys, and press the  key twice). If you do not need to make a setting, just press the  key.
 
11. Set the proportional band (1.P), integral time (1.I), and derivative time (1.D) in the same manner (that is, select the value you want to set using the  and  keys, and press the  key twice).
 
12. Press the  key twice to return to the loop-1 operation menu (O.LP1).
 

4.9 Setting Other Functions (as necessary)

Set the functions described in this section as necessary.

This section describes the parameter setting procedure using the setting of the direct/reverse action of control as an example. Set other parameters in the same way, as necessary.

Before setting, confirm the setting range of parameters referring to the parameter lists in Appendixes 3 and 4. When you set parameters, the parameter maps in Appendix 5 are helpful because they illustrate the display sequence and locations of the parameters. You can use the maps as an operation guide to call up the parameters you want to set or change.

If you are also using loop-2, set loop-2 parameters in the same manner as the loop-1 parameters.



See Also

See chapter 3 of the separate 'US1000 Digital Indicating Controller Functions' manual, for detailed information on each parameter.

(1) Direct/reverse action of control

You can specify either a direct or reverse action of control.

Menu: [Operation parameter]-[O.LP1/O.LP2]-[1.PID]

Parameter: 1.DR











● Setting Direct/Reverse Action of Control

First, determine the values of the parameters to be set by referring to the parameter list in Appendix 3.

Look at the operation parameter map in Appendix 5. Find the main menu "O.LP1" and check that the submenu "1.PID" is located below it. Then, find the parameter "1.DR" below the submenu "1.PID."

The parameter map shows the keys (by key symbols) used in reaching the parameter "1.DR" starting from an operation display.

Perform the following operations looking at the parameter map.

1. First, press the  key for 3 seconds from an operation display to call up "MODE."
2. Next, press the  key once to call up "O.LP1."
3. Press the  key to call up "PAR."
4. Press the  key once to call up "1.PID."
5. Press the  key several times until the "1.DR" parameter is displayed.
6. Change the setting using the  or  key. A decimal point will appear and flash.
7. Press the  key to register the new setting. Then, the decimal point disappears.
8. When all the settings are finished, press the  key to return to the submenu.
9. Pressing the  key at a submenu returns to the main menu.
Pressing the  key at a main menu returns to an operation display.

Set the following parameters referring to the parameter lists in Appendixes 3 and 4 and the parameter map in Appendix 5, as done for the direct/reverse action parameter setting.

(2) PV filter and PV bias

First order lag filtering function, and bias adding function used for correction in reference junction compensation

Menu: [Operation parameter]-[O.LP1/O.LP2]-[PAR]

Parameter: BS (PV bias), FL (PV filter)

(3) 10-segment linearizer

Can be selected as one of the following two functions.

Biasing: Provides biasing on any arbitrary 11 points of input.

Approximation: Output values can be arbitrarily set against the arbitrary 11 points of input.

Menu: [Operation parameter]-[PYS1]

Parameter: 1.X1 to 1.X11, 1.Y1 to 1.Y11, 1.PMD

(4) Burnout action

Sets the action upon detection of a burnout (wire breakage) for the thermocouple, RTD, and the standard signal inputs.

Menu: [Setup parameter]-[CMLP]-[AIN]

Parameter: A.BO1, A.BO2, A.BO3

(5) Cascade input source

The cascade input source can be selected as either an analog input terminal or as RS-485 communication. (The factory-set default is analog input terminal.)

When you use the feedforward input instead of the cascade input, set the CMS parameter to “CPT”.

Menu: [Setup parameter]-[S.LP1/S.LP2]-[SV]

Parameter: CMS

(6) Feedforward input

To use the feedforward input, set the FFS parameter to “AIN” and set the CMS (cascade input source) parameter to “CPT”. A filter and computation for feedforward input are provided.

Menu: [Setup parameter]-[S.LP1]-[CTL]

Parameter: FFS

Menu: [Operation parameter]-[O.LP1]-[PAR]

Parameter: FGN, FBI, FBO, FFL

(7) Square-root computation

Square-root extraction with changeable low signal cut-off point.

Menu: [Setup parameter]-[CMLP]-[AIN]

Parameter: A.SR1, A.LC1, A.SR2, A.LC2, A.SR3, A.LC3

(8) SUPER function

This function suppresses overshoots. It is more effective when used together with the auto-tuning function.

Menu: [Operation parameter]-[O.LP1/O.LP2]-[PAR]

Parameter: SC

(9) PV tracking

This function prevents a sudden changes in PV by temporarily making SV track PV when the controller is switched to AUTO mode.

Menu: [Setup parameter]-[S.LP1 / S.LP2]-[SV]

Parameter: PVT

(10) SV ramp-up/ramp-down rate

This functions is used as an SV changing operation, to gradually change SV toward the new value at a constant rate.

Menu: [Setup parameter]-[S.LP1/S.LP2]-[SV]

Parameter: TMU (time unit for ramp-rate setting)

Menu: [Operation parameter]-[O.LP1 / O.LP2]-[PAR]

Parameter: UPR, DNR (setpoint ramp-up/ramp-down)

(11) Cycle time of MV output (Pulse width of on/off signal)

The pulse width of an on/off signal in time proportional PID computation is proportional to the cycle time of the MV output.

Pulse width of MV output = MV output (%) × cycle time of MV output

Menu: [Setup parameter]-[CMLP]-[C.CTL]

Parameter: CT1, CT2

(12) Preset PID

You can set multiple sets of PID parameters. For detailed information about preset PIDs, read section 3.10 of the separate 'US1000 Digital Indicating Controller Functions' manual.

Menu: [Setup parameter]-[CMLP]-[C.CTL]

Parameter: PPID (specifies either SV number selection or zone PID)

(13) Behavior upon power recovery

You can set the type of controller behavior upon power recovery.

HOT: Continues the same operation as prior to power failure.

COLD: Starts in MAN mode. Outputs the preset MV value.

Menu: [Setup parameter]-[CMLP]-[C.CTL]

Parameter: R.MD

(14) Retransmission output

The function to re-transmit PV, MV, and SV data as an analog signal.

Menu: [Setup parameter]-[CMLP]-[RET]

Parameter: RET1, RTH1, RTL1, RET2, RTH2, RTL2, RET3, RTH3, RTL3

(15) Password setting for parameter change operation

You can set a password to prevent accidental or careless changes to setup parameter settings. The password is verified in the transmission from the operation parameter display to the setup parameter display.

The password setting range is from 0 (no password) to 30000.

**NOTE**

- Be sure to memorize the password. Once a password has been set, you cannot transmit to the setup parameter setting display without entering the correct password. To cancel a lost password, the controller must be sent back to a Yokogawa service center for repair at your cost.
- In the repair service, all parameters are initialized to the factory-set defaults. Thus, it is recommended to keep records of the user-set values for all of the parameters.

Menu: [Setup parameter]-[CMLP]-[MLCK]

Parameter: PWD

(16) Prohibition of key operation and parameter setting

You can disable (i.e., lock) specific operation keys and set specific operation parameter menus so that they will not be displayed.

Menu: [Setup parameter]-[CMLP]-[KLCK]

Parameter: SVC (SV setting key lock at operation displays)

▽/△ (Data setting key lock)^{*1}

</> (MV operation key lock)

C (C mode key lock)

A (A mode key lock)

M (M mode key lock)^{*2}

Menu: [Setup parameter]-[CMLP]-[MLCK]
Parameter: MODE (Mode menu lock)
 O.LP1 (O.LP1 menu lock)
 O.LP2 (O.LP2 menu lock)
 PID (PID submenu lock)*3
 USR (USR menu lock)
 PYS1 (PYS1 menu lock)
 PYS2 (PYS2 menu lock)

- *1: Disables all parameter setting operations except those for the parameters included in the key lock submenu KLCK and the password setting parameter.
- *2: While the setup parameter menu (STUP) is displayed, the M mode key lock becomes invalid and the operation mode can be switched to MAN.
- *3: Locks all of the submenus of 1.PID through to 8.PID.

(17) Calibration of valve position (US1000-21 only)

To perform position proportional control, you must set the valve position data of 0% and 100% openings to the controller.

You can calibrate the valve position either automatically or manually.



NOTE

Perform this calibration with the controller connected to the control valve.

Menu: [Setup parameter]-[USMD]-[VALV]
Parameter: V.RS, V.L, V.H, V.AT

● Calibrating the valve position (manually)

1. Display the V.RS parameter listed under the menu above. If V.RS is flashing, it means that the valve position has not been calibrated yet.

Press the  key to select "1." (If it is already 1, set it back to 0 first and then reset it to 1.)

Press the  key to reset the valve position settings.

2. Press the  key to display the V.L parameter.

Press and hold down the  key. This operates to close the valve and decrease the value on the SV digital display. When the digital value stops decreasing, the valve is fully closed.

Press the  key. The 0% opening is adjusted, and the SV digital display indicates 0.

3. Press the  key to display the V.H parameter.

Press and hold down the  key. This operates to open the valve and increase the value on the SV digital display. When the digital value stops increasing, the valve is fully opened.

Press the  key. The 100% opening is adjusted, and the SV digital display indicates 100.

● Calibrating valve position (automatically)

1. Call up the V.AT parameter, and press the  key to select "ON."

Press the  key. The parameter starts flashing. When it stops flashing, calibration is completed.

If "ERR" is displayed, there may be some trouble in the wiring, valve, or process. Press the  key to clear the error, and check the valve, process status, and so on.

5. Customizing Operation Displays

In addition to the standard operation displays, two types of operation displays can be created according to your needs.

● USER Display

Data that needs to be referred to during the normal operation display sequence, can be displayed on the digital display. These displays are called “USER displays.” You can transfer from the last operation display to the USER display using the **DISP** key. When more than one USER display has been registered, the USER displays appear in sequence every time the **DISP** key is pressed.

● SELECT Display

You can select the operation parameters that are frequently checked or modified by simply calling them up from an operation display. This resulting display is called a “SELECT display.” You can call up SELECT displays from any operation display by pressing the **SELECT** key for less than 3 seconds. If you press the key for more than 3 seconds, the mode menu appears. In this case, go back to an operation display by pressing the **DISP** key and try again. When more than one SELECT display has been registered, the SELECT displays appear in sequence every time the **SELECT** key is pressed. To return to an operation display, press the **DISP** key.

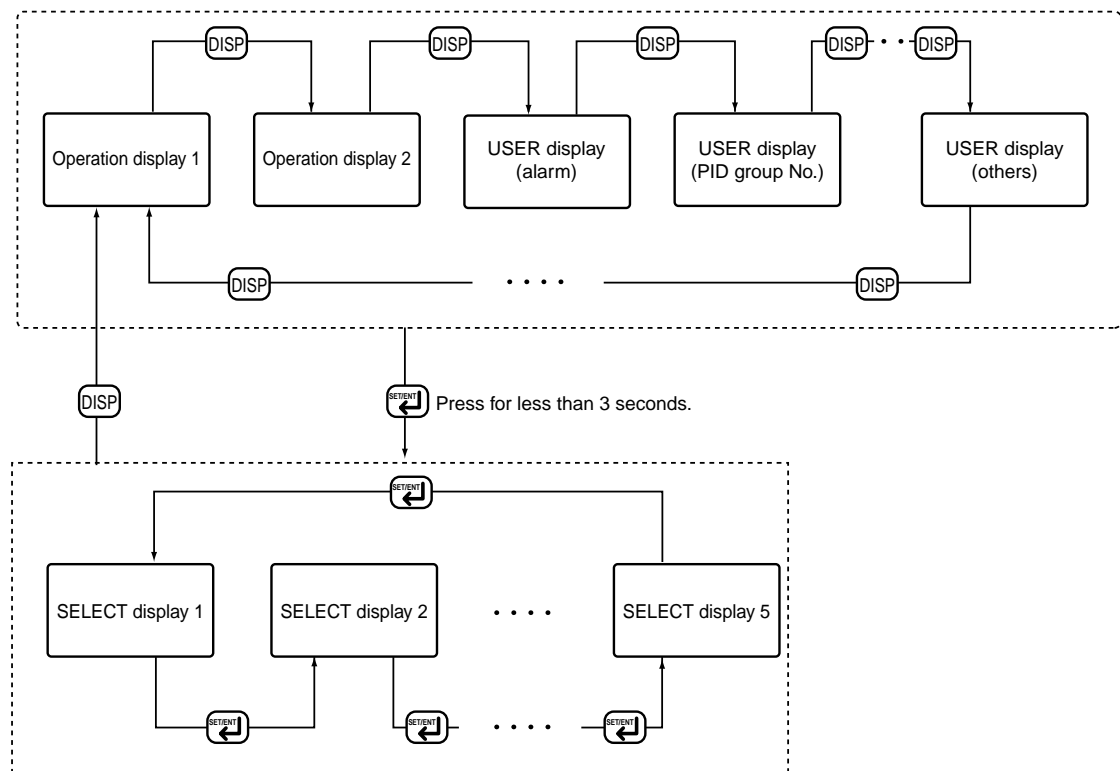

5.1 Registering Auxiliary Operation Displays (USER Displays)

The types of USER displays are listed in the table below. You can select and register the USER displays you need during operation. The registered displays are then displayed using the **DISP** key in the order shown in the table. The initial values of the parameters in the table are all “OFF” (not registered). Set the parameters you want to register to “ON.”

Menu: [Setup parameter] - [CONF] - [U.OPE]

Parameter	Meaning	PV digital display	SV digital display
U. 1AL	Loop-1 alarm	L1. ALM	Number of occurring alarm (1 - 4)
U. 2AL	Loop-2 alarm	L2. ALM	Number of occurring alarm (1 - 4)
U. SVN	SV number	SVNO	Specified SV number (1 - 8)
U. 1PI	Loop-1 PID group number	L1. PID	Current PID group number (1 - 8) for zone PID
U. 2PI	Loop-2 PID group number	L2. PID	Current PID group number (1 - 8) for zone PID
U. AI1	AIN1 measured value	AIN1	AIN1 value (engineering unit)
U. AI2	AIN2 measured value	AIN2	AIN2 value (engineering unit)
U. AI3	AIN3 measured value	AIN3	AIN3 value (engineering unit)
U. PV1	PV1	PV1	PV1 value (engineering unit)
U. PV2	PV2	PV2	PV2 value (engineering unit)
U. SMP	Sampling error counter	SMP. ER	Error counter (0 - 30000)



See Also

- See section 3.10 of the separate ‘US1000 Digital Indicating Controller Functions’ manual, for SV number and zone PID.
- See section 3.17 of the separate ‘US1000 Digital Indicating Controller Functions’ manual, for sampling error counter.

■ Examples of USER Display

● USER display of Loop-1 alarm

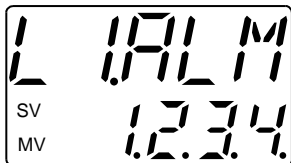

Alarms 1 to 4 are all activated

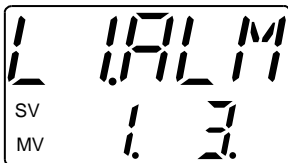

Alarm 1 and 3 are activated

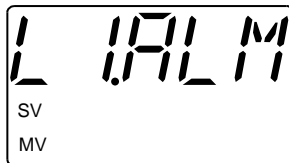

No alarm in occurrence

● USER display of SV number

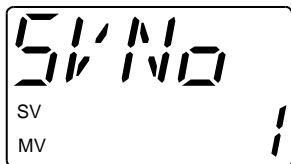

Specified SV number is 1.

● USER display of loop-1 PID group number



Current PID group number for zone PID is 2.

● USER display of AIN1 measured value

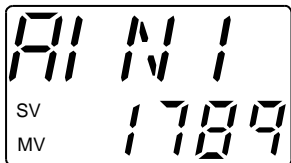

AIN1 = 1789

● USER display of PV1

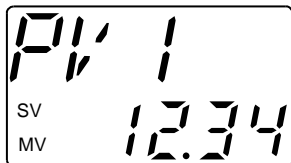

PV1 = 12.34

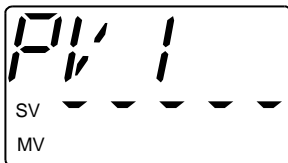

PV1 overflow

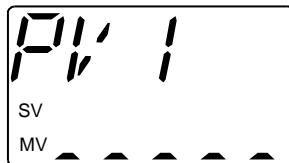

PV1 underflow

● USER display of sampling error counter

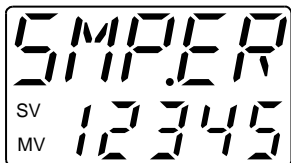

Error count is 12345.

■ Registering USER Displays

1. If the controller is not in MAN mode, press the **(M)** key to change to MAN mode.
In an operation display, pressing the **(SET/ENT)** key for 3 seconds will retrieve the mode menu (MODE) or loop-1 operation mode (O.LP1). (O.LP1 is displayed for the default setting.)

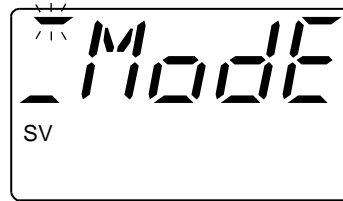

2. Press the **(V)** key once to display the setup menu (STUP).
Then press the **(SET/ENT)** key once.
If a password has been set, input the password here.

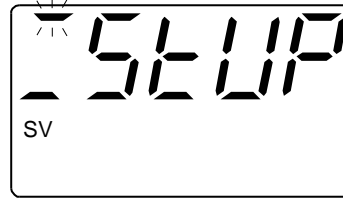

3. The loop-1 setup menu (S.LP1) appears.
Press the **(Δ)** key several times to display the detailed function setup menu (CONF).

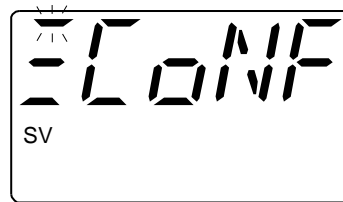

4. Press the **(SET/ENT)** key once to display the SELECT display registration submenu (C.SEL).
Then press the **(Δ)** key once to display the USER display registration submenu (U.OPE).

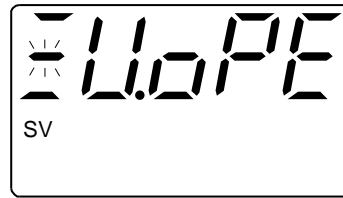

5. Press the **(SET/ENT)** key to display the USER display of the loop-1 alarm parameter (U.1AL).
To register the USER display for use during operation, press the **(Δ)** key and select "ON," and then press the **(SET/ENT)** key. (If you do not need the USER display, leave it "OFF" and press SET/ENT key.)

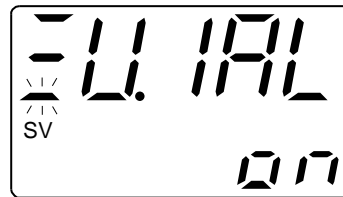

6. Press the **(SET/ENT)** key to display the next USER display registration parameter. Set the parameters for the USER displays you want to "ON" in the same way as for U.1AL above.

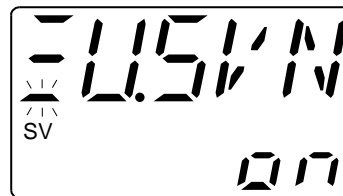

7. Press the **(DISP)** key for 3 seconds to return to the operation display.



5.2 Displaying the Alarm Status

If the USER display functions described in the previous section are used, you can display alarm statuses from an operation display by pressing the **DISP** key.

To set up the alarm status display function, perform the following.

1. Define alarm actions: Refer to section 4.7, “Defining Alarm Outputs.”
2. Set alarm setpoints: Refer to section 4.8, “Setting Target Setpoint, Alarm Setpoints, and PID Parameters.”
3. Set the U.1AL or U.2AL (USER display) parameter to ON:
Refer to section 5.1, “Registering Auxiliary Operation Displays (USER Displays).”

5.3 Registering Quick Parameter Call-up Functions (SELECT Displays)

You can register up to 5 SELECT displays. An operation parameter that is frequently checked or modified during operation should be registered as a SELECT display. Registration involves setting the D-register numbers of operation parameters. The D-register numbers are given in the table on the next page.

■ Examples of SELECT Display

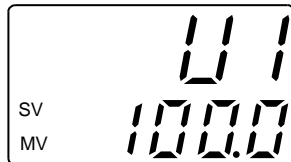

SELECT display for the U1 parameter

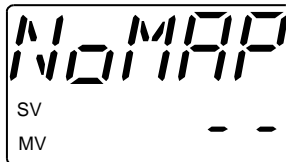

A register number with no allocated parameter has been set for SELECT display 2.*1

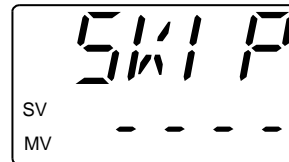

A register number of non-displayable parameter has been set for SELECT display 4.*2

*1: If you happen to register a D-register number that is not allocated to a parameter (i.e., a D-register number not found in the table on the next page), the SELECT display will indicate “NoMAP” followed by as many hyphens as the number of digits in the SELECT display number (1 to 5 digits).

*2: Some parameters are not displayed depending on the controller mode (US mode) and the model and suffix code of the controller. If you register such parameters, the SELECT display will indicate “SKIP” followed by as many hyphens as the number of digits in the SELECT display number (1 to 5 digits).

■ Parameters to Register SELECT Displays

Main menu	Submenu	Parameter	Description	Range of setting	Default
CONF	C. SEL	C.S1 - C.S5	Registration of SELECT display 1 to 5	OFF, 201 to 773	OFF

■ D-register Numbers of Operation Parameters

No.	Parameter	No.	Parameter	No.	Parameter	No.	Parameter	No.	Parameter	No.	Parameter	No.	Parameter
	Mode		Loop-1 3. PID		Loop-1 6. PID		Loop-2 1. PID		Loop-2 4. PID		Loop-2 7. PID		Ten-segment linearizer 1
206	O/C	351	3. SV	426	6. SV	501	1. SV	576	4. SV	651	7. SV	726	1. X1
207	SVNO	352	3. A1	427	6. A1	502	1. A1	577	4. A1	652	7. A1	727	1. Y1
	Loop-1 computation parameters	353	3. A2	428	6. A2	503	1. A2	578	4. A2	653	7. A2	728	1. X2
241	AT. 1	354	3. A3	429	6. A3	504	1. A3	579	4. A3	654	7. A3	729	1. Y2
242	SC. 1	355	3. A4	430	6. A4	505	1. A4	580	4. A4	655	7. A4	730	1. X3
243	BS. 1	356	3. P	431	6. P	506	1. P	581	4. P	656	7. P	731	1. Y3
244	FL. 1	357	3. I	432	6. I	507	1. I	582	4. I	657	7. I	732	1. X4
245	UPR. 1	358	3. D	433	6. D	508	1. D	583	4. D	658	7. D	733	1. Y4
246	DNR. 1	359	3. MH	434	6. MH	509	1. MH	584	4. MH	659	7. MH	734	1. X5
247	CRT. 1	360	3. ML	435	6. ML	510	1. ML	585	4. ML	660	7. ML	735	1. Y5
248	CBS. 1	361	3. MR	436	6. MR	511	1. MR	586	4. MR	661	7. MR	736	1. X6
249	CFL. 1	362	3. H	437	6. H	512	1. H	587	4. H	662	7. H	737	1. Y6
250	FGN. 1	363	3. DR	438	6. DR	513	1. DR	588	4. DR	663	7. DR	738	1. X7
251	FBI. 1	364	3. Pc	439	6. Pc	514	1. Pc	589	4. Pc	664	7. Pc	739	1. Y7
252	FBO. 1	365	3. Ic	440	6. Ic	515	1. Ic	590	4. Ic	665	7. Ic	740	1. X8
253	FFL. 1	366	3. Dc	441	6. Dc	516	1. Dc	591	4. Dc	666	7. Dc	741	1. Y8
	Loop-2 computation parameters	367	3. Hc	442	6. Hc	517	1. Hc	592	4. Hc	667	7. Hc	742	1. X9
271	AT. 2	368	3. DB	443	6. DB	518	1. DB	593	4. DB	668	7. DB	743	1. Y9
272	SC. 2	369	3. RP	444	6. RP	519	1. RP	594	4. RP	669	RHY	744	1. X10
273	BS. 2	370	3. PM	445	6. PM	520	1. PM	595	4. PM	670	7. PM	745	1. Y10
274	FL. 2	371	3. PMc	446	6. PMc	521	1. PMc	596	4. PMc	671	7. PMc	746	1. X11
275	UPR. 2		Loop-1 4. PID		Loop-1 7. PID		Loop-2 2. PID		Loop-2 5. PID		Loop-2 8. PID	747	1. Y11
276	DNR. 2	376	4. SV	451	7. SV	526	2. SV	601	5. SV	676	8. SV	748	1. PMD
277	CRT. 2	377	4. A1	452	7. A1	527	2. A1	602	5. A1	677	8. A1		Ten-segment linearizer 2
278	CBS. 2	378	4. A2	453	7. A2	528	2. A2	603	5. A2	678	8. A2	751	2. X1
279	CFL. 2	379	4. A3	454	7. A3	529	2. A3	604	5. A3	679	8. A3	752	2. Y1
	Loop-1 1. PID	380	4. A4	455	7. A4	530	2. A4	605	5. A4	680	8. A4	753	2. X2
301	1. SV	381	4. P	456	7. P	531	2. P	606	5. P	681	8. P	754	2. Y2
302	1. A1	382	4. I	457	7. I	532	2. I	607	5. I	682	8. I	755	2. X3
303	1. A2	383	4. D	458	7. D	533	2. D	608	5. D	683	8. D	756	2. Y3
304	1. A3	384	4. MH	459	7. MH	534	2. MH	609	5. MH	684	8. MH	757	2. X4
305	1. A4	385	4. ML	460	7. ML	535	2. ML	610	5. ML	685	8. ML	758	2. Y4
306	1. P	386	4. MR	461	7. MR	536	2. MR	611	5. MR	686	8. MR	759	2. X5
307	1. I	387	4. H	462	7. H	537	2. H	612	5. H	687	8. H	760	2. Y5
308	1. D	388	4. DR	463	7. DR	538	2. DR	613	5. DR	688	8. DR	761	2. X6
309	1. MH	389	4. Pc	464	7. Pc	539	2. Pc	614	5. Pc	689	8. Pc	762	2. Y6
310	1. ML	390	4. Ic	465	7. Ic	540	2. Ic	615	5. Ic	690	8. Ic	763	2. X7
311	1. MR	391	4. Dc	466	7. Dc	541	2. Dc	616	5. Dc	691	8. Dc	764	2. Y7
312	1. H	392	4. Hc	467	7. Hc	542	2. Hc	617	5. Hc	692	8. Hc	765	2. X8
313	1. DR	393	4. DB	468	7. DB	543	2. DB	618	5. DB	693	8. DB	766	2. Y8
314	1. Pc	394	4. RP	469	RHY	544	2. RP	619	5. RP	694	RDV	767	2. X9
315	1. Ic	395	4. PM	470	7. PM	545	2. PM	620	5. PM	695	8. PM	768	2. Y9
316	1. Dc	396	4. PMc	471	7. PMc	546	2. PMc	621	5. PMc	696	8. PMc	769	2. X10
317	1. Hc		Loop-1 5. PID		Loop-1 8. PID		Loop-2 3. PID		Loop-2 6. PID		User parameters	770	2. Y10
318	1. DB	401	5. SV	476	8. SV	551	3. SV	626	6. SV	701	U1	771	2. X11
319	1. RP	402	5. A1	477	8. A1	552	3. A1	627	6. A1	702	U2	772	2. Y11
320	1. PM	403	5. A2	478	8. A2	553	3. A2	628	6. A2	703	U3	773	2. PMD
321	1. PMc	404	5. A3	479	8. A3	554	3. A3	629	6. A3	704	U4		
	Loop-1 2. PID	405	5. A4	480	8. A4	555	3. A4	630	6. A4	705	U5		
326	2. SV	406	5. P	481	8. P	556	3. P	631	6. P	706	U6		
327	2. A1	407	5. I	482	8. I	557	3. I	632	6. I	707	U7		
328	2. A2	408	5. D	483	8. D	558	3. D	633	6. D	708	U8		
329	2. A3	409	5. MH	484	8. MH	559	3. MH	634	6. MH				
330	2. A4	410	5. ML	485	8. ML	560	3. ML	635	6. ML				
331	2. P	411	5. MR	486	8. MR	561	3. MR	636	6. MR				
332	2. I	412	5. H	487	8. H	562	3. H	637	6. H				
333	2. D	413	5. DR	488	8. DR	563	3. DR	638	6. DR				
334	2. MH	414	5. Pc	489	8. Pc	564	3. Pc	639	6. Pc				
335	2. ML	415	5. Ic	490	8. Ic	565	3. Ic	640	6. Ic				
336	2. MR	416	5. Dc	491	8. Dc	566	3. Dc	641	6. Dc				
337	2. H	417	5. Hc	492	8. Hc	567	3. Hc	642	6. Hc				
338	2. DR	418	5. DB	493	8. DB	568	3. DB	643	6. DB				
339	2. Pc	419	5. RP	494	RDV	569	3. RP	644	6. RP				
340	2. Ic	420	5. PM	495	8. PM	570	3. PM	645	6. PM				
341	2. Dc	421	5. PMc	496	8. PMc	571	3. PMc	646	6. PMc				
342	2. Hc												
343	2. DB												
344	2. RP												
345	2. PM												
346	2. PMc												

■ Registering SELECT Displays

1. If the controller is not in MAN mode, press the **(M)** key to change to MAN mode.
In an operation display, pressing the **(SETENT)** key for 3 seconds will retrieve the mode menu (MODE) or loop-1 operation mode (O.LP1). (O.LP1 is displayed for the default setting.)

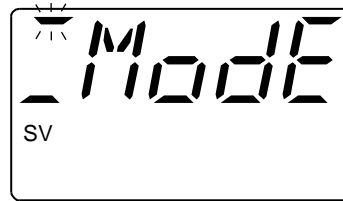

2. Press the **(V)** key once to display the setup menu (STUP).
Then press the **(SETENT)** key once.
If a password has been set, input the password here.

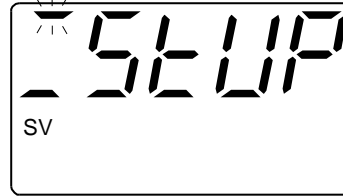

3. The loop-1 setup menu (S.LP1) then appears.
Press the **(A)** key several times to display the detailed function setup menu (CONF).

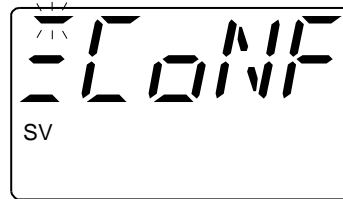

4. Press the **(SETENT)** key once to display the SELECT display registration submenu (C.SEL).

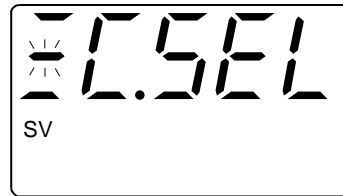

5. Press the **(SETENT)** key to enable registration of the SELECT display 1 parameter (C.S1).
Find the D-register number of the operation parameter you want to register in the table on the previous page, and set it using the **(A)** and **(V)** keys.
Example: To register the alarm-1 setpoint (1.A1), set "302."

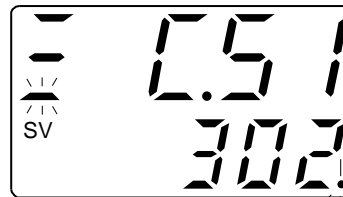

6. Press the **(SETENT)** key to register the setting. The decimal point stops flashing.

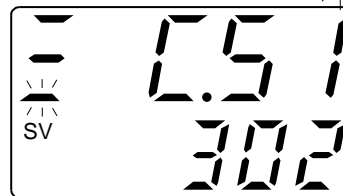

7. Press the **(SETENT)** key once again to enable registration of the SELECT display 2 parameter (C.S2). Set the parameters of other SELECT displays (C.S2 to C.S5) as necessary, and in the same manner as done for C.S1.

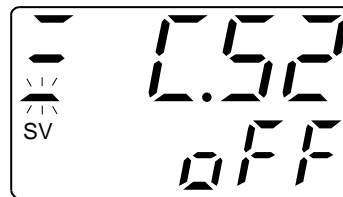

8. Press the **(DISP)** key for 3 seconds to return to the operation display.

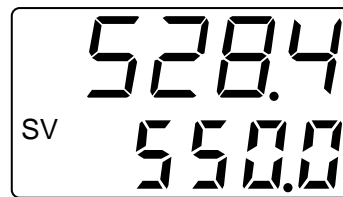

6. Operation

Now that you have completed the installation, wiring and functionality setup procedures described in the previous chapters, you can actually start operating the US1000.

This chapter describes the basic operations of the US1000 and specific operations for individual controller modes (US modes). It also explains basic tuning work and switching among the CAS, AUTO, and MAN modes by the contact inputs.



TIP

This chapter describes the controller operation of the following three types of controllers depending on their selected controller mode (US mode).

Controller type	Preset controller mode (US mode)
Single-loop type	Single-loop control, cascade primary-loop control, cascade secondary-loop control, loop control for backup, loop control with PV switching, loop control with PV auto-selector, loop control with PV-hold function, loop control with PV switching and two universal inputs, loop control with PV auto-selector and two universal inputs
Cascade type	Cascade control, cascade control with two universal inputs
Dual-loop type	Dual-loop control, temperature and humidity control

■ Operation Display

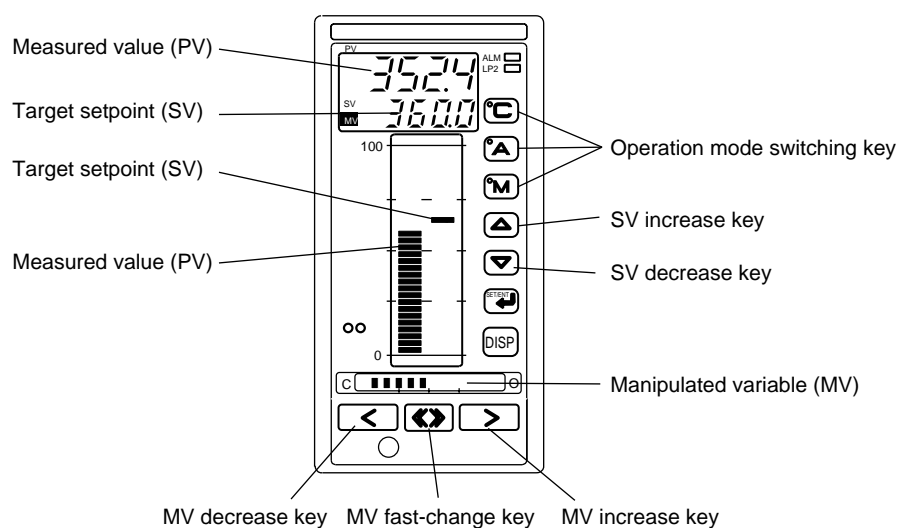

6.1 Switching the Operation Mode

■ US1000 Operation Modes

The US1000 can operate under one of the following operation modes:

MAN mode: In this mode, MV can be manipulated manually using the MV operation keys.

AUTO mode: This mode performs automatic control so as to maintain the SV. SV can be changed using the SV setting keys on the front panel.

CAS mode: This mode performs automatic control, regarding the cascade input from either an analog input signal or from RS-485 communication as the target setpoint.

■ Switching the Operation Mode



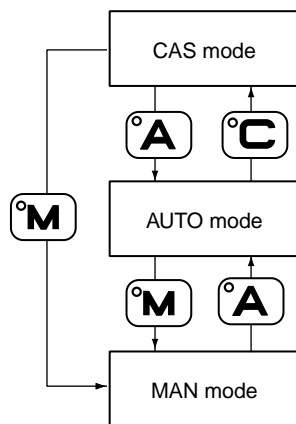

To switch the operation mode, press and hold either the **◻C** (CAS mode), **◻A** (AUTO mode) or **◻M** (MAN mode) key for 0.5 sec. to switch between modes, as follows:



NOTE

- The **◻C** key is locked (disabled) for the default setting to avoid undesirable mode change. So, release the C mode key lock first, before you can enter the CAS mode. (See section 4.9 (16) for the information about key lock.)
- You cannot switch directly from the MAN mode to CAS mode. You must switch to the AUTO mode first, before you can enter the CAS mode.
- Even if the cascade-input signal is -5.0% or less or 105.0% or more, the operation mode can be switched to the CAS mode.

6.2 Changing the Target Setpoint (SV)

Use the  (SV increase) or  (SV decrease) key to change SV. If the controller is in CAS mode, SV cannot be changed. If this is the case, you will need to press the  or  key to change the operation mode to the AUTO or MAN mode before you can change the SV.

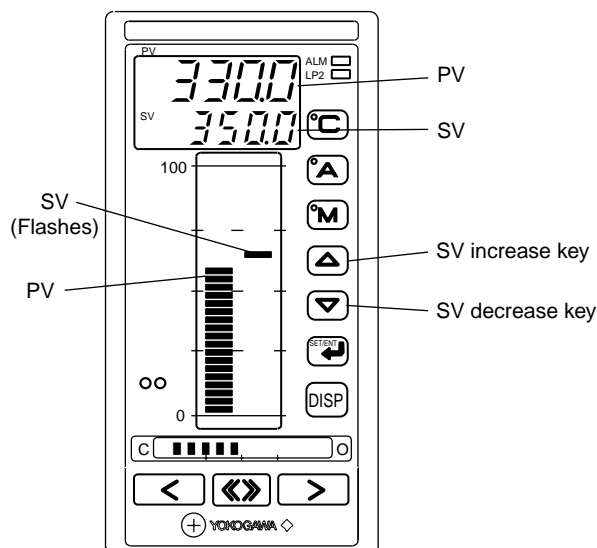



Pressing the  (SV increase) key increments SV.

Pressing the  (SV decrease) key decrements SV.



TIP

- When the deviation between SV and PV exceeds the value of parameter DVB, the bar segment of SV flashes.
- Pressing either of the  or  key displays SV on the SV digital display. (If MV was being displayed, the display automatically switches to the SV display.)

6.3 Manipulating MV

As the controller is switched to the MAN mode, **M** (MAN mode lamp) goes on, and MV becomes available for incrementing or decrementing. To operate MV, use **←** or **→** and/or **↔** key.

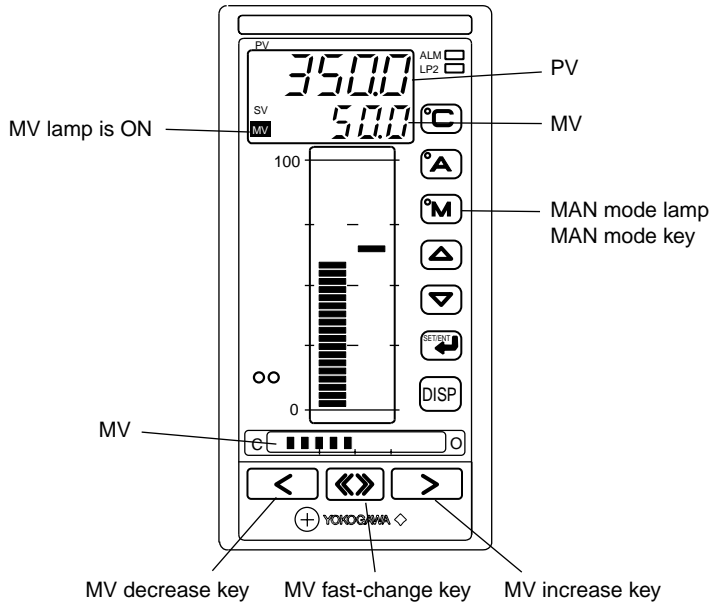

If the controller is set to other than the MAN mode, press the **M** key to enter the MAN mode.

To increase MV, press the **→** MV increase key.

To decrease MV, press the **←** MV decrease key.

To accelerate the increasing or decreasing operation, press the **←** or **→** key while pressing the **↔** key.



TIP

- To change MV, make sure the operation mode is MAN (i.e., the M mode lamp is on).
- To display MV on the SV digital display, press the **←** or **→** key. The MV lamp will then light up. (If SV was being displayed, the display automatically changes to the MV display.)
- You can also switch the SV digital display from SV to MV using the **DISP** key.

■ Shutdown Function

This function fully closes a control valve beyond its positioner deadband. This function is available when the output type is current of 4 to 20 mA and the operation mode is MAN.

When output is reduced using the **↓** key until “SHUT” appears on the SV digital display, the shutdown function starts to operate and the output falls to approx. 0.0 mA.

6.4 Operations on Single-Loop Type of Controller

This section describes the operation displays that appear in the following controller modes (US modes), and their corresponding operations:

- Single-loop control
- Cascade primary-loop control
- Cascade secondary-loop control
- Loop control for backup
- Loop control with PV switching
- Loop control with PV auto-selector
- Loop control with PV-hold function
- Loop control with PV switching and two universal inputs
- Loop control with PV auto-selector and two universal inputs

It is possible to switch between the two digital display combinations of PV and SV or PV and MV, using the **[DISP]** key at anytime during operation. The following operations are also available:

- Changing the operation mode using the **[C]**, **[A]** or **[M]** key
- Changing SV using the **[▲]** or **[▼]** key (only in AUTO or MAN mode)
- Manipulating MV using the **[◀]** or **[▶]** and/or **[↔]** key (only in MAN mode)

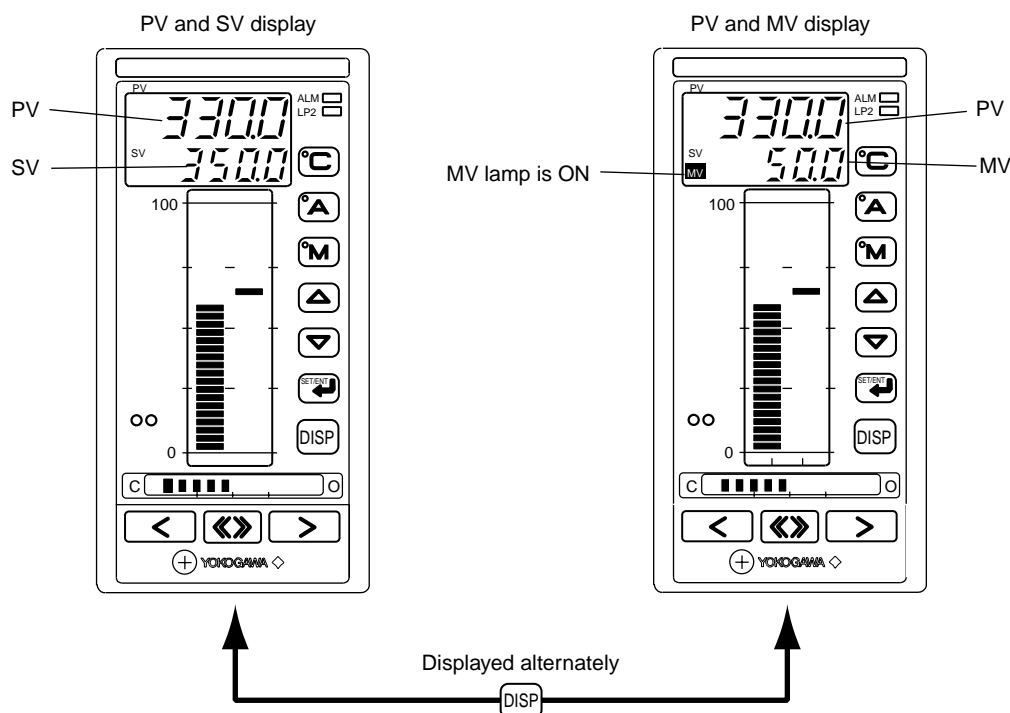

6.5 Operations on Cascade Type of Controller

This section describes the operation displays that appear in the following controller modes (US modes), and their corresponding operations:

- Cascade control
- Cascade control with two universal inputs

The operation displays and operations available on cascade type of controllers depend on whether the cascade is closed or opened.

■ Operation Display and Operations for Cascade Close

“Cascade Close” refers to the state where the two loops, the primary and secondary loops of the US1000, are connected. In this status, the secondary loop conducts control assuming the result of the PID computation at the primary loop as the target setpoint. The status has two combination patterns of digital operation display, the primary PV and primary SV, and the primary PV and secondary MV. To switch between them, use **DISP** key.

- Changing the operation mode using the **C**, **A** or **M** key
- Changing the primary SV using the **▲** or **▼** key (only in AUTO or MAN mode)
- Manipulating MV using the **◀** or **▶** and/or **◀▶** key (only in MAN mode)



See Also

Section 6.6, “Switching Between Cascade Open and Close,” for information on switching between cascade open and close.

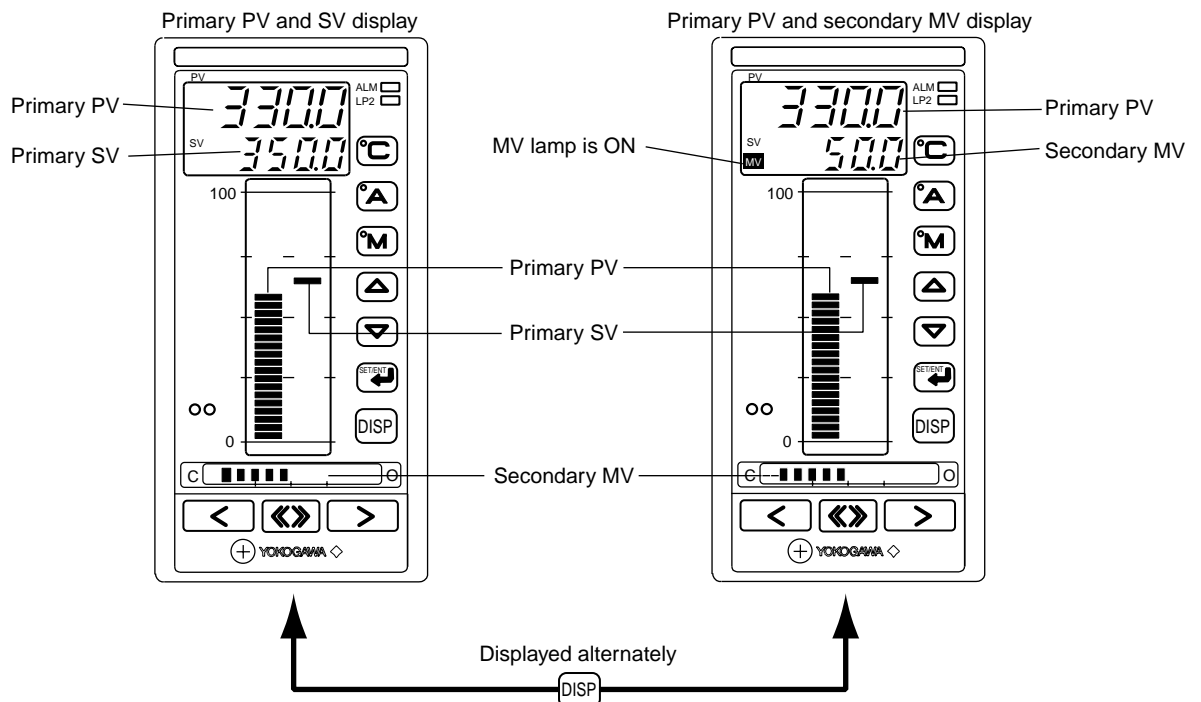

■ Operation display and operations for cascade open

“Cascade Open” refers to the state where the two loops, the primary and secondary loop in the US1000, are disconnected. In this status, the secondary loop obtains the manually set SV as a basis to conduct control. The left-side bar display shows the primary loop’s PV and SV, while the right-side one shows the secondary loop’s PV and SV. SV is indicated by the flashing bar-graph segment.

“Cascade Open” has two digital operation-display combinations: secondary PV and secondary SV; and secondary PV and secondary MV. To switch between these, use the **[DISP]** key.

When the cascade is opened, LP2 lamp is ON and the currently selected mode lamp flashes.

- Changing the operation mode using the **[C]**, **[A]** or **[M]** key
- Changing the secondary SV using the **[▲]** or **[▼]** key
- Manipulating MV using the **[◀]** or **[▶]** and/or **[↔]** key (only in MAN mode)



See Also

Section 6.6, “Switching Between Cascade Open and Close,” for information on switching between cascade open and close.

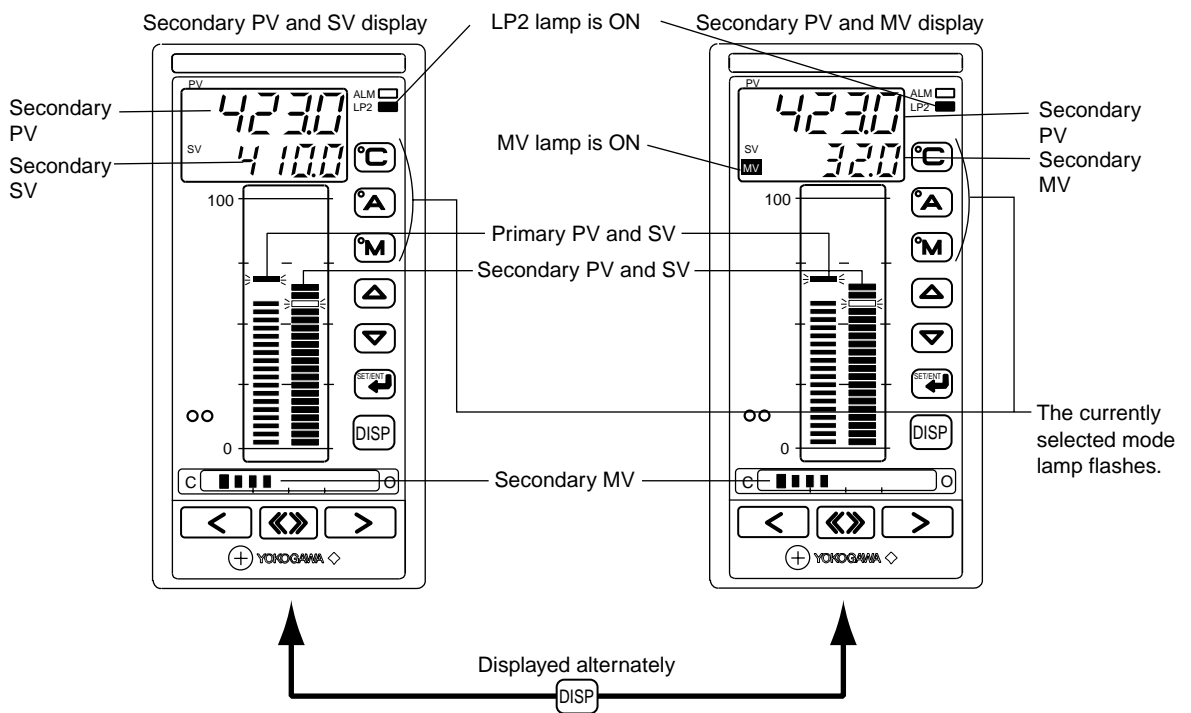

6.6 Switching Between Cascade Open and Close

Two ways are available to switch between the cascade open and close as follows:





- **Switching using parameters**
- **Switching using contact**

Note that the latter has precedence over the former.

■ Parameters for switching between cascade open and close



Activate the OPEN/CLOSE switchover (O/C) parameter from the operation parameter mode menu (MODE) in order to change the settings.

● Switching between cascade open and close

1. Press the  key on the operation display for 3 sec. to display the mode menu (MODE).
2. Press the  key again to display the OPEN/CLOSE switchover (O/C) parameter.
3. Press the  or  key to change the parameter setting. A decimal point appears and starts to flash.

CLOSE: **Switch to close status**

OPEN: **Switch to open status**

4. Press the  key to store the changed parameter condition. The decimal point disappears.
5. Press the  key to return to the operation display.

■ Contact input for switching between cascade open and close

For cascade controllers, a contact input terminal is assigned for cascade open/close switching.

Contact input terminal: DI2

When DI2 is ON: Cascade open

When DI2 is OFF: Cascade close

6.7 Operations on Dual-loop Type of Controller

This section describes the operations in the following controller modes (US modes):

- Dual-loop control
- Temperature and humidity control

In dual-loop type of controllers, both of the US1000's two internal control loops performs the PID control computations.

The left-side bar display shows the loop-1's PV and SV, while the right-side one shows the loop-2's PV and SV.

- SV is indicated by the flashing bar-graph segment.
- When the secondary loop's information is displayed, the LP2 lamp lights up.

The following operations are available for the *displayed loop* (see note below):

- Changing the operation mode using the **C**, **A** or **M** key
- Changing SV using the **▲** or **▼** key (only in AUTO or MAN mode)
- Manipulating MV using the **◀** or **▶** and/or **⏪** key (only in MAN mode)

Note

For example, if you press the **M** key during the loop-2 display (i.e., when the LP2 lamp is on), then the operation mode for the loop-2 changes to MAN. The operation for the loop-1 is not affected.

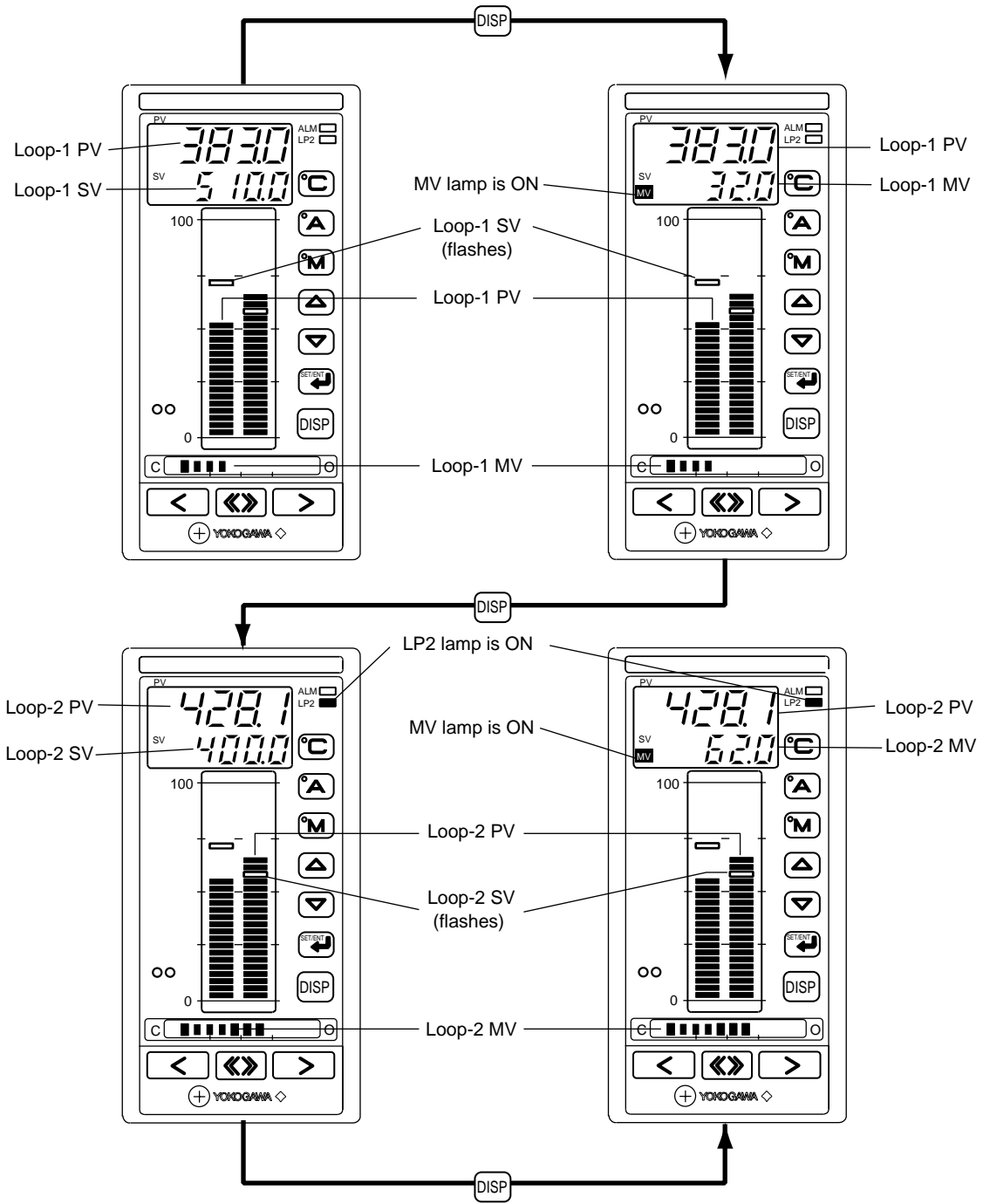

6.8 Display and Operations during Heating/Cooling Computation

The following displays are those specific to the heating/cooling computation.

● Digital display for MV

“H” is indicated at the left of the heating-side MV

“L” is indicated at the left of the cooling-side MV

If both the heating and cooling computations are being output, the heating-side is displayed.

● Bar-graph display for MV

The heating side appears on the right half of the bar display and the cooling side on the left half. For both the heating and cooling sides, the center of the bar display indicates the 0.0% level. The right and left ends of the bar display indicate 100.0% for the heating and cooling sides respectively. The lower limit of the output is 0.0%.

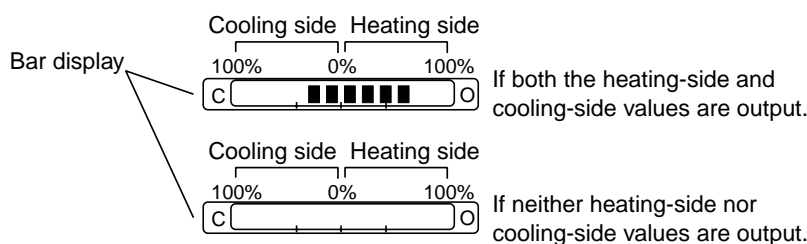
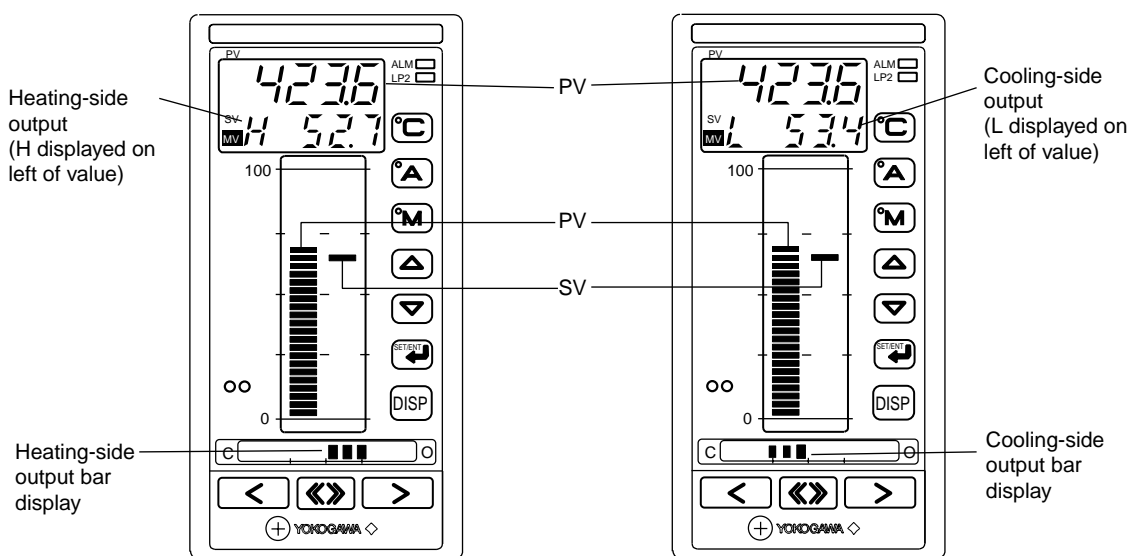

6.9 Operation Mode Switching Using Contact Input

A contact input is assigned with the function of switching the operation modes. The assignment depends on the controller mode (US mode) as outlined below. A mode transition occurs when the contact input status changes from OFF to ON.



See Also

Section 3.15 of the 'US1000 Digital Indicating Controller Functions' manual for changing the contact input assignment.

- **For single-loop control, loop control with PV auto-selector or loop control with PV auto-selector and two universal inputs:**

DI2: Switches to MAN mode

DI3: Switches to AUTO mode (for US1000-11 and -21 only)

- **For cascade primary-loop control, loop control for backup, loop control with PV switching or loop control with PV switching and two universal inputs:**

DI3: Switches to MAN mode (for US1000-11 and -21 only)

- **For cascade secondary-loop control, cascade control or cascade control with two universal inputs:**

DI3: Switches to MAN mode (for US1000-11 and -21 only)

DI4: Switches to AUTO mode (for US1000-11 and -21 only)

DI5: Switches to CAS mode (for US1000-11 and -21 only)

- **For loop control with PV-hold function:**

DI2: When on, PV and MV are held in MAN mode; when OFF, switches to AUTO mode

DI3: Switches to CAS mode (for US1000-11 and -21 only)

- **For dual-loop control and temperature and humidity control:**

DI2: Switches secondary loop to MAN mode (for US1000-11 only)

DI3: Switches primary loop to MAN mode (for US1000-11 only)

6.10 Starting Controller Operation

This section explains how to start the controller operation, using simple PID control as an example.

■ Starting manual operation

1. Turn the power on. The PV and SV digital values, and PV, SV and MV bar displays appear.
2. The **(M)** lamp lights up, indicating the controller is in MAN mode.
3. Press the **(▲)** or **(▼)** key to set SV.
4. Press **(◀)** or **(▶)** key to turn on the MV lamp and display the MV value on the digital display.
Adjust MV, as necessary.
Balance PV at or around SV, while checking for a smooth response.

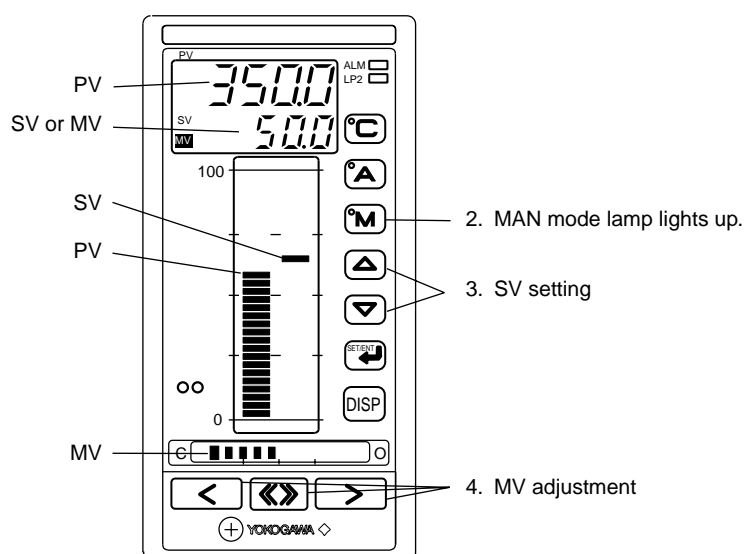

■ Switching from manual to automatic operation

To change the operation mode to AUTO, press the **(A)** key in step 4 in the above sequence (and the AUTO mode lamp lights up). No balancing is required when switching and the output will change without a bump.

6.11 Auto-tuning

Auto-tuning is a US1000 function that measures the process characteristics and automatically sets the optimum PID parameters during PID control. Auto-tuning is activated by the parameter setting.

The auto-tuning uses a “Stepping Response Method.” When auto-tuning is activated, MV output turns on and off temporarily in a step-like manner. An appropriate PID is calculated and set from the response data.



WARNING

Do not use the auto-tuning function for the following processes.

- Fast-response processes such as flowrate and pressure.
 - Processes in which a severe change in output, even if temporary, is undesirable.
 - Processes in which any severe stress on the operating terminal is undesirable.
 - Processes in which product quality can be adversely affected if PV fluctuates beyond its allowable range.
-



CAUTION

- Auto-tuning is only available when the operation mode is set to AUTO.
 - Before auto-tuning can be performed, the target setpoints and other parameters must be set up.
 - Auto-tuning is not available for ON/OFF computation control.
 - Auto-tuning is disabled when the US1000 is inactive.
-





TIP

- To interrupt auto-tuning, set the AT parameter to off. Auto-tuning stops and the PID constant stays unchanged at the same value as before auto-tuning was started.
 - Even if SV is changed during auto-tuning, auto-tuning is still based on the SV set when started. After completing auto-tuning, control is conducted according to the modified SV.
 - Changing a PID constant during auto-tuning is not made effective, since the constant is reset when auto-tuning ends. The parameters are not reset when auto-tuning is terminated forcibly however, thus making the changed values effective.
 - If an input burnout or A/D data conversion error occurs during auto-tuning, auto-tuning stops and outputs the preset MV value.
 - If auto-tuning is run for more than 24 hours, it is terminated upon the auto-tuning timeout time and the error code “ATERR” is displayed. To dismiss the error code, press the **[DISP]** key once. The error will not affect the US1000 functions. It is recommended that the process be checked to find out the cause of the timeout.
 - Auto-tuning on a zone PID control is performed using the PID parameters corresponding to the SV number to which the auto-tuning parameter is set, despite the SV number using in the zone PID control.
 - Performing auto-tuning on a zone PID does not affect any SV number not being set in the zone PID function.
-

■ Starting autos-tuning

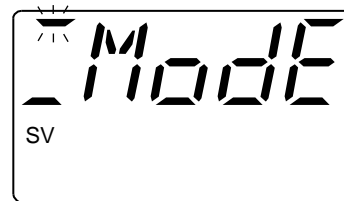
1. Press the  key for 3 sec. from an operation display to call up the mode menu (MODE).



2. Press the  key once to call up the loop-1 operation menu (O.LP1).

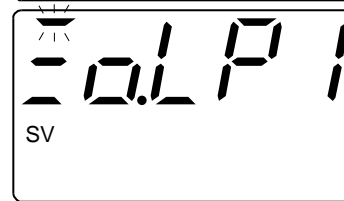

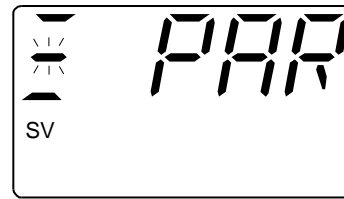

3. Press the  key once to call up the computation parameter submenu.

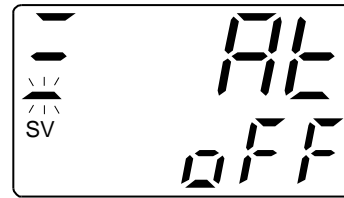

4. Press the  key once to display the auto-tuning selection parameter (AT).



5. Press the  or  key to select the SV number for auto-tuning and press the  key.
Example: To perform auto-tuning using the PID parameters for SV number 1, select 1. To perform auto-tuning for all SV numbers, select 9.

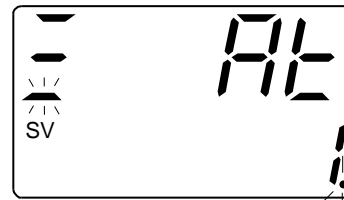

6. The display switches to the operation display. When auto-tuning is run, the LED's at both ends of the MV bar display flash. They cease flashing when auto-tuning stops.

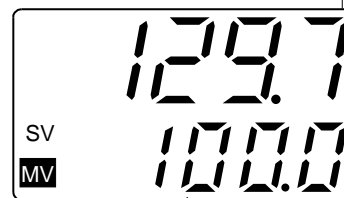

The LED's at both ends flash.

The value of upper and lower limit of output is output alternately during auto-tuning.

6.12 Manual Tuning

To using the US1000 with an unknown process, clarify the conditions for MAN mode operation as this will help you determine the proportional band, integral time and derivative time for the AUTO mode. For example, if PV varies considerably by changing the US1000 output slightly, the proportional band shall be set wide. Conversely, if PV varies only slightly with changes in output, then the proportional band shall be set narrow. In addition, if only a short delay time is allowed for changes made to the controller's MV, then the integral time and derivative time must be set short. For processes which have longer recovery time, the integral time and derivative time must be set long.

■ Tuning with Gegalr/Nichols's Limiting Sensitivity

There are a number of adjustments that can be made to determine the proportional band, integral time and derivative time. The method described here yields a response characteristic of 25% damping.

1. Set the operation mode to MAN and manipulate PV manually so that it matches SV. Set the integral time to 9999 sec., the proportional band to a large value and the derivative time to OFF.
2. Set the control operation mode to AUTO.
3. Decrease the proportional band from its large value (e.g., 100% → 50% → 20%). In this case, allow enough time to pass so that the control conditions can be monitored at every step. Continue this operation until the control loop starts continuous oscillation (cycling).



TIP

Cycling occurs when the proportional band is set narrower than the band allowed by the maximum value of the process, and is evident by the regular oscillation of PV around SV at the center.

4. Locate the point at which cycling starts. Measure the proportional band value (PBu) and cycling frequency (Pu).
5. The optimum PID parameter setpoints are yielded as follows:
Proportional band (P): 1.7 PBu
Integral time (I) : 0.5 Pu
Derivative time (D) : 0.125 Pu

6.13 Stopping Controller Operation

Use the contact input to stop the US1000.

Contact input terminal symbol: D11

OFF : Run

ON : Stop

When the US1000 is stopping, the word “STOP” and a PV value appear alternately on the PV digital display.

The stopping conditions are as follows;

- Control computations: Continued.
- MV output: Equals the preset output value (set in the **n.PM** operation parameter) if the operation mode is AUTO or CAS; can be changed using ◀ or ▶ key if the operation mode is MAN.
- PV digital display: Alternates between the “STOP” indication and the PV value.
- SV digital display: Gives either the SV value or the MV value (switched with the **DISP** key).
- SV bar display: Continues to give the same SV value as that before the controller stopped.
- PV bar display: Gives the PV value.
- MV bar display: Gives the MV value.

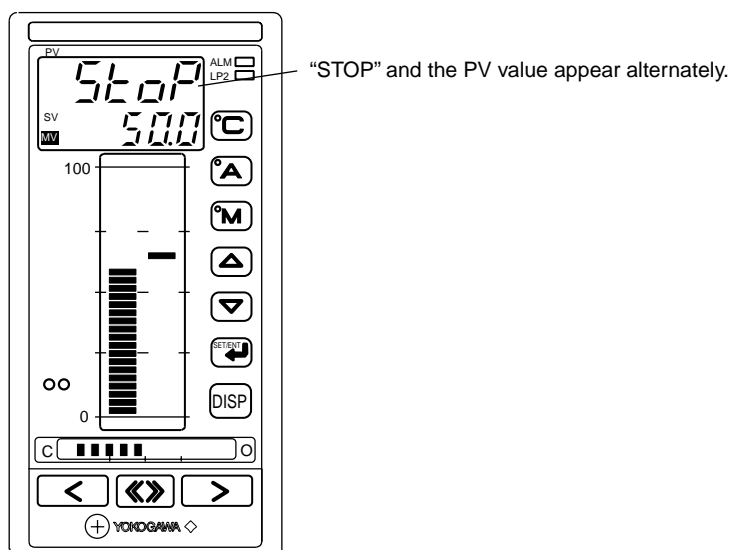

6.14 Power Failure during Operation

The US1000's operation is not affected by power failures of less than 20 ms (i.e., normal operation continues). If the power loss continues for 20 ms or more, the following operations result:

- Alarm action : Continues, unless the alarm is with waiting action, in which case the alarm immediately returns to the waiting status.
- Setting parameters: The set parameters are maintained.
- Auto-tuning : Released.

If a power failure continues for 2 sec. or more, the control action upon recovery depends on the restart mode (R.MD) set in the setup parameters, as follows:

R.MD setpoint	Control action after recovery
HOT	Operation mode and MV continue after recovery.
COLD	Starts in MAN (manual operation) after recovery. MV is reset to the preset MV value ('n.PM' of operation parameters).

7. Other Functions

The communication functions on the US1000 can be configured as optional specifications and the LL1200 PC-based custom computation building tool is also available optionally. This chapter outlines the communication functions available and the custom computation function. It also briefly describes the data (D register and I relay) kept internally by the US1000.

7.1 Communication Functions

The US1000 can exchange data via communication with connected PCs, PLCs or graphic panels. The D register and I relay of the US1000 are used to exchange data. The communication functions are optional and must be specified for inclusion at time of ordering if required.

- Maximum number of connected units: 31
- Maximum communication distance: 1200 m
- Communication protocol: Either Modbus or PC link

● Setup parameters used for communication functions

Main menu	Submenu	Parameter	Description	Option or range	Initial value
CMLP	R485	PSL	Protocol selection	0: Modbus (ASCII) 1: Modbus (RTU) 2: PC link communication 3: PC link communication (with sum-check)	0
		BPS	Baud rate	600, 1200, 2400, 4800, 9600, 19200, 38400 bps	9600
		PARI	Parity	N: Disabled; E: Even parity; O: Odd parity	E
		STP	Stop bit	1, 2	1
		DLN	Data length	7, 8	8
		ADR	Controller address	1 to 99	1
		RSP.T	Minimum response time	0 to 10 (x 10 ms)	0



See Also

The “US1000 Single Loop Controller Communication Functions” instruction manual (IM 5D1A01-10E)

7.2 Custom Computation

If the standard functions of the US1000 controller mode (US mode) do not offer the type of control desired, you can customize the I/O computations, signal assignment and operation display. These functions are called 'custom computation functions'.

To use this custom computation functions, you will need the "LL1200 PC-Based Custom Computation Building Tool" that is available optionally. The "LL1200 PC-Based Custom Computation Building Tool" is accompanied by the "LL1100 PC-based Parameters Setting Tool."

● Main Specifications of Custom Computation Functions

Available computation modules: Four-rule arithmetic, logic operation, ten-segment linearizer approximation, temperature and humidity calculation, fluid temperature compensation, fluid pressure compensation, etc.

Customizable operation display: Display elements, display sequences, and display conditions

7.3 D Register and I Relay

The D register and I relay are not used for normal operations. The only operations that require D register and I relay numbers to be specified, are:

- Customizing the operation display
- Referring to the parameters for custom computation
- Communication with other devices
- Customizing signals assigned to the I/O contact

■ What is a D register?

D register refers to the CPU registers used by Yokogawa's digital controllers and programmable controllers, that keep data on a word-basis.

The US1000 stores all process data, setting parameters and definition information in this so-called 'D register.' All US1000 data are managed by referring to their individual D register numbers.

■ What is an I relay?

The US1000 stores its status conditions, such as the operation mode or alarm condition, in a so-called "I relay." All status's are managed by referring to their individual I relay numbers.

8. Maintenance

This chapter describes how to clean and maintain the US1000.

8.1 Cleaning

The US1000 front panel should be cleaned gently with a soft, dry cloth.



NOTE

Do not use organic solvents such as alcohol or benzene as the body material may deteriorate.

8.2 Replacement of Mounting Bracket

If the mounting bracket is damaged, please order a replacement, specifying the following serial number.

Part No.	Selling unit
T9115NK	One set (upper and lower brackets)

8.3 Limited Life Components and Maintenance

The following table lists those controller components with a limited life.

Components	Length of service life
Aluminum electric capacitor	7 to 10 years
EEPROM	100,000 writings
Contact output relay	About 100,000 on/off repetitions *1
Control output relay	About 100,000 on/off repetitions *1

*1: This service life is guaranteed only for the rated load.

It is recommended that the US1000 be overhauled according to the limited-life data for each component. The control output relays can be replaced. But to carry out the replacement, contact YOKOGAWA sales staff or Repair Center because the inspection is required for safety.



TIP

Comments on fuse :

The fuses employed in US1000 are free from periodically replacement because it is not a short-life part. To carry out fuse replacement, sufficient handling skill of the instrument and also soldering skill are required. In case that the fuse has burned out, please contact YOKOGAWA sales staff or Repair Center.

Part Name	Part No.	Rated Current	Rated Voltage	Fuse Characteristics
Fuse	A1422EF	1.6A	250V	Quick acting (F)

8.4 Procedure for Replacing Control Output Relays



NOTE

Since inspection is needed in case parts are replaced, replacement will be carried out by a YOKOGAWA engineer or an engineer certified by YOKOGAWA. When replacement is required, contact your nearest YOKOGAWA dealer.



WARNING

To avoid electric shock, turn off the power before starting replacement work allowing for the influence upon the process and other instruments.

■ Required tools

- Phillips screwdriver
- Control output relay: OMRON G6B-2114P-FD-US-P6B
Rated to 30 V DC or 250 V AC
Resistance load of 3 A

■ Replacing

1. Turn off the US1000 and the external power supply for the relay contacts.
2. Insert a Phillips screwdriver into the lower hole on the bezel of the front panel at an angle of 90° from the front panel and loosen the screw.
3. Hold the bezel of the front panel and gently pull it straight out towards you. Be careful not to pull it out on an angle, as the temperature sensor on the terminal face may be damaged.
4. Remove the I/O board fitted with control output relays from the bezel, as instructed below. The I/O board is fixed to the bezel at the top and bottom.
 - 4.1) Gently push up the top of the bezel and unlatch the I/O board's upper claw from the bezel's hole.
 - 4.2) Gently push down the bottom of the bezel and unlatch the I/O board's lower claw from the bezel's hole.
 - 4.3) Open the I/O board outward. At that moment, be careful not to place stress on the cable connections.
5. Remove the fastening band that fixes the relays in place from the socket using tweezers or the like.
6. Pick up the control output relay and gently pull it out from the socket as shown in the figure.
7. Connect a new control relay to the socket.
8. Insert the fastening band into the socket until it clicks into place.
9. Mount the I/O board back onto the bezel. First, insert the I/O board's lower claw into the bezel's lower hole. Next, force the I/O board's upper claw into the bezel's upper hole.
10. Replace the front panel onto the case.
11. Turn on the power to make sure the initial screen appears. If the display remains inactive or becomes abnormal, try pulling the front panel out and replacing it again.

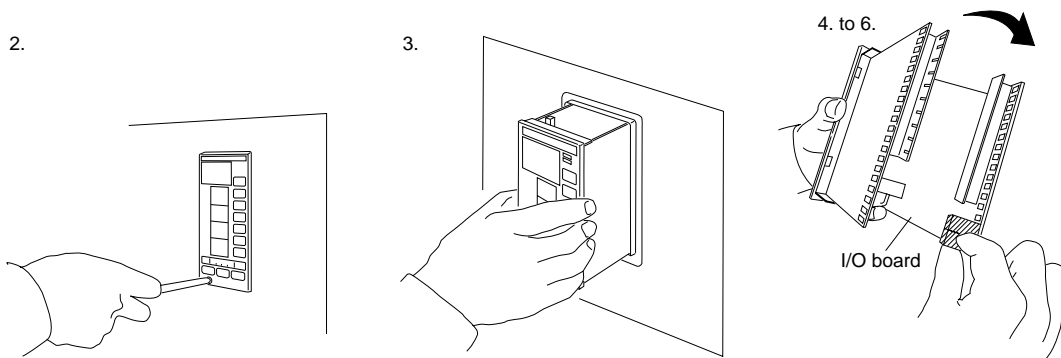

8.5 Problems and Corrective Measures

If the US1000 seems to operate improperly, take the appropriate corrective actions explained in section 8.5.1, “Troubleshooting.” If an error code appears, take the appropriate action specified in section 8.5.2, “Error Code Description.”



TIP

Shipping the product back for repair

For repair service requests, contact the dealer where you purchased the controller. As a rule, ship the defective product in the same packing box in which the product came delivered.

8.5.1 Troubleshooting

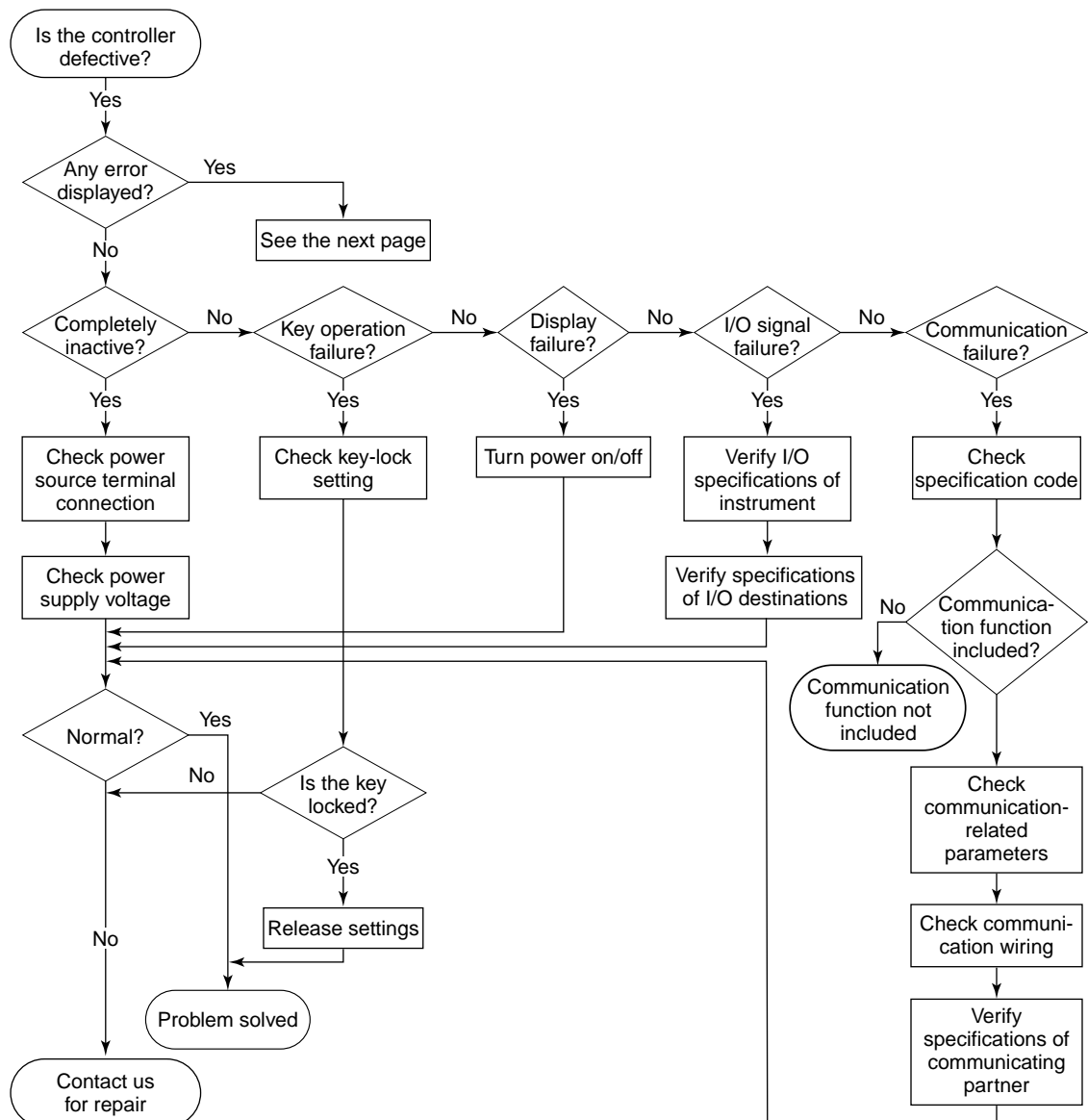

NOTE

When replacing an instrument, the customized parameters are all initialized to their factory-set default values. Be sure to write down the customized parameters required before returning it.

8.5.2 Error Code Description

When turning on the power or during operation, an error code or the flashing decimal point may appear on the display. The following describes what the individual error codes or flashing decimal point mean and the remedies for such occurrences.

■ Possible errors on power-up

● Possible errors displayed on PV digital display

Error code display	Error content	Manipulated variable (MV)	Remedy	Error display clear
E000	RAM failure	Nothing output	Contact us	—
E001	ROM failure	Nothing output	Contact us	—
E002	System data abnormal	Nothing output	Contact us	—
Rightmost decimal point flashes	Calibration value abnormal	Output continues	Contact us	DISP key

● Possible errors displayed on SV digital display

When a parameter failure is encountered, a corresponding detailed error code in hexadecimal notation appears on the lower two digits of the SV digital display.

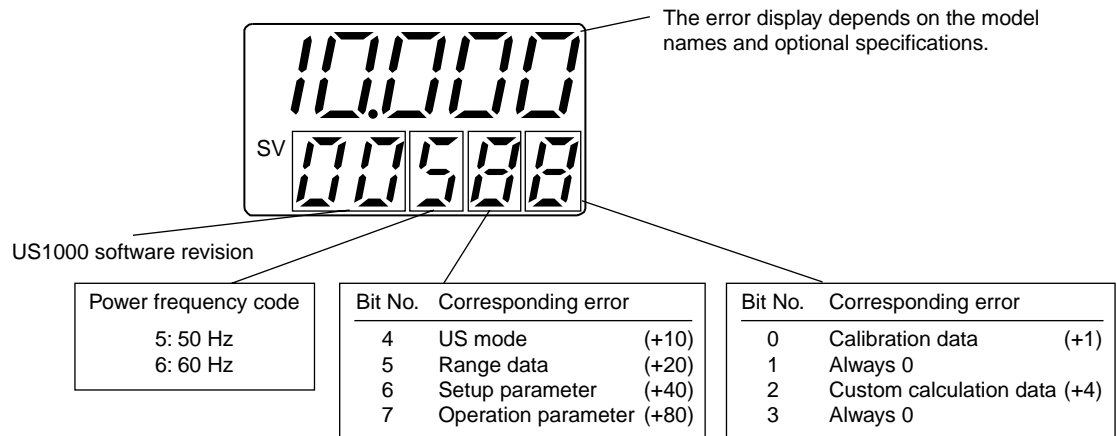

The sum of the values in the parentheses in the figure shown above is indicated as an error code.

Display example

Calibration data and operation parameters are abnormal

81

Range data and setup parameters are abnormal

60

■ Possible errors during operation

● Possible errors displayed on PV digital display

If ADERR (analog/digital converter circuit abnormal) appears, the cascade is set to open.

Error code display	Error content	Manipulated variable (MV)	Remedy	Error display clear
'RJC' and PV values appear alternately	Reference junction compensation failure	Continues	Contact us	—
OVER or -OVER	PV overflow or PV underflow	Continues	Check control target device /circuit	—
ADERR	Analog/digital conversion circuit failure	Preset MV for AUTO mode, continues for MAN mode	Check wiring	—
ATERR	Auto-tuning error	Continues with same PID value as before starting auto-tuning	Check control target device	DISP key
Rightmost decimal point flashes, all the others are switched off	CPU failure	Nothing output	Contact us if this problem repeats itself after turning the controller off and on.	—
Leftmost decimal point flashes	Communication circuit failure	Continues	Check communication wiring	DISP key
All indicators have disappeared	Dead wire condition	Nothing output	Check power supply	—

● Possible errors displayed on SV digital display

The cascade is set to open when B.OUT (input burnout) appears.

Error code display	Error content	Manipulated variable (MV)	Remedy	Error display clear
"E." on leftmost LED flashes	EEPROM failure	Continues	Contact us	—
B. OUT	Input burnout	Preset MV for AUTO mode, continues for MAN mode.	Check wiring	—
— — — — —	Analog input overflow	Continues	Check process	—
— — — — —	Analog input underflow	Continues	Check process	—
ERR	Automatic valve calibration error	Continues	Check process	DISP key

Blank Page

Appendix 1 Hardware Specifications



CAUTION

This equipment has Measurement category I, therefore do not use the equipment for measurements within measurement categories II, III and IV.

Measurement category	Description	Remarks
I	CAT. I For measurements performed on circuits not directly connected to MAINS.	
II	CAT. II For measurements performed on circuits directly connected to the low voltage installation.	Appliances, portable equipments, etc.
III	CAT. III For measurements performed in the building installation.	Distribution board, circuit breaker, etc.
IV	CAT. IV For measurements performed at the source of the low-voltage installation.	Overhead wire, cable systems, etc.

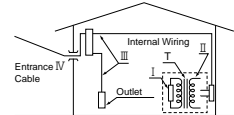

■ Input/Output Signal Specifications

* The performance under standard operating conditions (temperature: $23 \pm 2^\circ\text{C}$; humidity: $55 \pm 10\%$ RH; power supply frequency: 50/60 Hz), are as follows.

• Analog inputs (1, 2) (Measurement category I)

Number of input points: 1 or 2

Rated input voltage: 10V DC max.

Input type, range, and accuracy: Refer to the input table of section 4.4.

Control period: 50, 100, 200, or 500 ms

Burnout detection Thermocouple input: Input bias current $0.05 \mu\text{A}$

RTD input: Input bias current $0.05 \mu\text{A}$

Standard signal input: 0.1 V or less

Input resistance Thermocouple and mV input: $1 \text{ M}\Omega$ or more

Standard signal and V input: Approx. $1 \text{ M}\Omega$

Allowable signal source resistance

Thermocouple and mV input: 250Ω or less

Standard signal and V input: $2 \text{ k}\Omega$ or less

Signal source resistance effect

Thermocouple and mV input: $0.1 \mu\text{V}/\Omega$ or less

Standard signal and V input: 0.01%/ 100Ω

Allowable lead wire resistance

RTD input: Maximum of $150 \Omega/\text{wire}$ (The resistance must be the same for all 3 wires.)

$10 \Omega/\text{wire}$ at -150 to 150°C

Allowable input voltage

Thermocouple, mV and RTD input: $\pm 10 \text{ V DC}$

Standard signal and V input: $\pm 20 \text{ V DC}$

Noise rejection ratio Normal mode: 40 dB (50/60 Hz) or more

Common mode: 120 dB (50/60 Hz) or more

Voltage across ground: 300V AC r.m.s max.

Rated transient overvoltage: 1500V ^(Note)

Note : It is a value on the safety standard which is assumed by IEC/EN61010-1 in measurement category I, and is not the value which guarantees an apparatus performance.

Reference junction compensation error

Thermocouple input: $\pm 1.0^\circ\text{C}$ (at 15 to 35°C) and $\pm 1.5^\circ\text{C}$ (at 0 to 15°C or 35 to 50°C)

Applicable standards Thermocouple and RTD: JIS / IEC / DIN

• **Analog input 3(Measurment category I)**

Number of input points: 1

Rated input voltage: 10V DC max.

Input type: 2 types.....Standard signal input: 1 to 5 V
.....DC voltage input: 0 to 10 V

Burnout detection: 0.1 V or less

Input accuracy: Standard signal and DC voltage input: $\pm 0.2\%$ of input span

Input resistance: Standard signal and DC voltage input: Approx. 1 M Ω

Allowable signal source resistance: 2K Ω or less

Signal source resistance effect: 0.01%/100 Ω

Allowable input voltage: ± 20 V DC

Sampling period: 100 ms

Noise rejection ratio Normal mode: 40 dB (50/60 Hz) or more

Common mode: 120 dB (50/60 Hz) or more

Voltage across ground: 300V AC r.m.s max.

Rated transient overvoltage: 1500V ^(Note)

Note : It is a value on the safety standard which is assumed by IEC/EN61010-1 in measurement category I, and is not the value which guarantees an apparatus performance.

• **Feedback resistance input (US1000-21 only)**

Number of input points: 1

Input type Slide wire resistance input with a total resistance of 100 Ω to 2.5 k Ω (and slide-wire breakage detection)

Measuring resolution: $\pm 0.1\%$ of total resistance (after user's adjustment)

Measuring span resistance: Arbitrary within total resistance (after user's adjustment)

Sampling period: 50 ms

• **Loop power supply for transmitter (1, 2)**

The Yokogawa BRAIN transmitter with communication function and the BRAIN terminal can be used.

Number of output points: 1 or 2

Power supply voltage: 25.5 \pm 1.5 V DC (at 4 to 20 mA)

Maximum supply current: 30 \pm 5 mA DC

• **MV output (1, 2)**

Current output

Number of output points 1 or 2

Output signal 4 to 20, 0 to 20, 20 to 4, or 20 to 0 mA DC
(Signals less than 0 mA cannot be output.)

Output accuracy $\pm 0.3\%$ of span

Load resistance 600 Ω or less

Output ripple 0.1% of F.S.(p-p) or less at 300 Hz

Voltage pulse output

Number of output points 1 or 2

Output signals 12 V or more for ON voltage; 0.1 V DC or less for OFF voltage.

Load resistance 600 Ω or more; short-circuit current is approx. 30 mA DC.

Minimum pulse width 10 ms or 0.1% of output, whichever is larger.

• **Relay contact output**

Number of output points 1 or 2

Output signals: NC, NO, and common terminals.

Contact rating: 250 V AC, 3A at 30 V DC, 3A (resistance load).

Resolution 10 ms or 0.1% of output, whichever is larger.

Minimum output working time 20 ms

- **Position proportional relay contact output (US1000-21 only)**

Number of output points 1 point made up of 2 contacts.
 Output signals H (direct rotation), L (reverse rotation), and common terminals.
 Contact rating 250 V AC, 3A at 30 V DC, 3A (resistance load).

- **Retransmission Output**

Number of output points 1
 Output signal 1 to 5, 0 to 5, 5 to 1, or 5 to 0 V DC
 (Signals below 0 V cannot be output.)
 Output accuracy $\pm 0.3\%$ of span
 Load resistance 2 k Ω or more
 Output ripple 0.1% of F.S.(p-p) or less at 300 Hz

- **Contact input**

Number of input points 2 or 7
 Input type Non-voltage contact or transistor open collector
 Contact capacity 5 V DC at 20 mA or more
 Signal detection Non-voltage contact inputs are ON when the contact resistance is 200 Ω or less, and OFF when it is 100 k Ω or more.
 Transistor open collector inputs are ON when voltage is 1 V DC or less, and OFF when leak current is 100 μ A or less.
 Minimum pulse width Three-times the control period

- **Contact output**

Number of output points 3 or 7
 Output type Relay contact or transistor open collector
 Contact capacity Relay contact: 240 V AC, 1A at 30 V DC, 1A (resistance load)
 Transistor open collector: 30 V DC, 200 mA (resistance load)

■ Conformance to Safety

Safety standard:

- General safety standard requirements IEC/EN61010-1
 - Certified for CSA1010
- The overvoltage category of each input is CATII (IEC1010-1)

EMC standards:

During test, the controller continues to operate with the measurement accuracy within $\pm 20\%$ of the range
 Compliant with EN61326.

CSA standard:

Non-incentive electrical equipment for use in hazardous locations
 C22.2 No. 213:
 Location Class I, division 2, Groups A, B, C, & D
 Temperature Code T4

FM standard:

Non-incentive electrical equipment for use in hazardous locations.
 FM 3611:
 Location Class I, Division 2, Groups A, B, C & D
 Class I, Zone 2, Group IIc
 Temperature Code T4

■ Construction, Installation, and Wiring

• Construction

Dust-proof and drip-proof (Conforms to IP65): Front panel (drip-proof construction is not available when controllers are mounted closely side-by-side)

Material of the body: (Modified polyphenylene-Ether Resin and polycarbonato)

Flame retardance grade: Housing: V-0; bezel: V-2 or better

Color of housing: Munsell 0.8Y 2.5 / 0.4 (CC24)

External dimensions: 72 (W) × 144 (H) × 150* (D) mm

* The depth dimension is from the mounting panel and does not include the terminal cover.

Weight: Approx. 800 g

• Mounting

Mounting: Direct panel mounting, fixed with upper and lower brackets

Mounting position: Inclined upward to a maximum of 30 degrees; not designed to be inclined downward.

Bracket tightening torque: 0.2 N•m (2 kgf•cm) or less

Panel cutout dimensions: $68^{+0.7}$ (W) × $137^{+2.0}$ (H) mm

• Wiring

Terminals: M3.5 screws (at signal, power supply, and grounding terminals)

Terminal tightening torque: 0.8 N•m (8 kgf•cm) or less

• Power Supply and Isolation

• Power supply

Rated voltage: 100 to 240 V AC ($\pm 10\%$), 50/60 Hz

Power consumption: 25 VA (11.0 W) at maximum

Allowable time for momentary power failure: 20 ms

Withstanding voltage: Primary terminal ↔ secondary terminal: 1500 V AC (see Note) for 1 minute

Primary terminal ↔ grounding terminal: 1500 V AC (see Note) for 1 minute

Grounding terminal ↔ secondary terminal: 1500 V AC for 1 minute

Note: 2300 V AC for safety purposes.

Primary terminal: Power supply and relay contact output terminals

Secondary terminal: Analog input/output, MV output, contact input, transistor open collector, and communication terminals

Isolation resistance Power supply terminal ↔ grounding terminal: 500 V DC at 20 M Ω or more

Grounding: Grounding resistance of no greater than 100 Ω

Circuit-breaker rating : Use a 5A circuit breaker (100/200V AC) in compliance with IEC60947-1 or IEC60947-3.

Install the breaker in the same room as the US1000, and clearly indicate that it is used to de-energize the US1000.

Installation in the same room as the US1000 is recommended.

• Isolation specifications

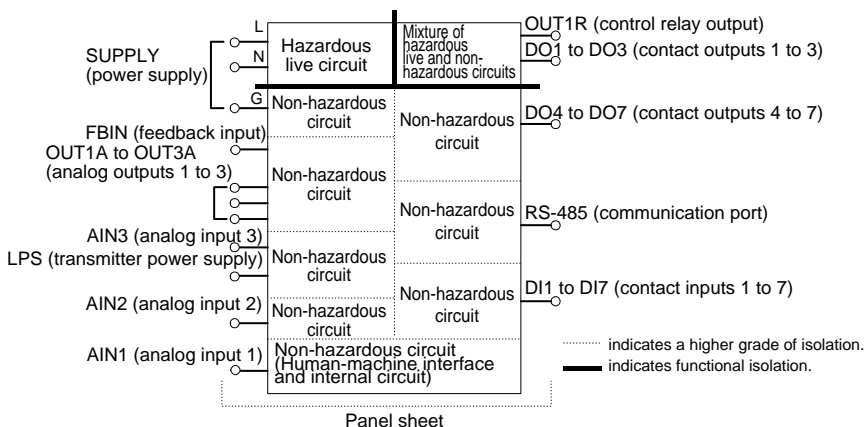

■ Environmental Conditions

- Normal operating conditions

Location: Indoor

Warm-up time: 30 minutes or more

Ambient temperature: 0 to 50°C (40°C or less for close side-by-side mounting)

Temperature gradient: 10°C/h or less

Ambient humidity: 5 to 90% RH (no condensation)

Magnetic field: 400 AT/m or less

Continuous vibration 5 to 14 Hz: Peak-to-peak amplitude of 1.25 mm or less

14 to 150 Hz: 4.9 m/s² (0.5G) or less

Short-period vibration 14.7 m/s² (1.5G) for no more than 15 s

Shock: 147 m/s² (15G) for no more than 11 ms

Installation height: Up to an altitude of 2,000 m (as per the heat radiation condition for equipment)

IEC61010 regulation: Installation category: II (see Note 1)

Pollution level: 2 (see Note 2)

Note 1: The “Installation category” implies the regulation for impulse with stand voltage. It is also called the “Overvoltage category”, “II” applies to electrical equipment.

Note 2: “Pollution level” describes the degree to which a solid, liquid or gas which deteriorates dielectric strength is adhering. “2” applies to a normal indoor atmosphere.

- Effects of operating conditions

Ambient temperature

Voltage and thermocouple input: $\pm 1 \mu\text{V}/^\circ\text{C}$ or $\pm 0.01\%$ of F.S./ $^\circ\text{C}$ or less

RTD input: $\pm 0.05^\circ\text{C}/^\circ\text{C}$ or less

Analog input 3: $\pm 0.02\%$ of F.S./ $^\circ\text{C}$ or less

Analog output: $\pm 0.05\%$ of F.S./ $^\circ\text{C}$ or less

Power supply (within rated voltage)

Analog input $\pm 1 \mu\text{V}/10 \text{ V}$ or $\pm 0.01\%$ of F.S./10 V or less

Analog output $\pm 0.05\%$ of F.S./10 V or less

- Transit and storage

Temperature: -25 to 70°C

Temperature gradient: 20°C/h or less

Humidity: 5 to 95% RH (no condensation)

Shock: The controller does not experience shock effects if dropped less than 1 m.

Blank Page

Appendix 2 Engineering Units Available for the US1000

For the US1000, settings can be made in engineering units such as °C. The US1000 contains two categories of engineering units: “EU” and “EUS.”

■ EU

“EU” is the engineering unit for the instrument range. Use “EU” to set a target setpoint, or the upper and lower alarm limits.

The notation, “EU (-100.0 to 100.0%),” is used to indicate the range of settings that can be set for each of the parameters listed in appendices 2 and 3. That is, parameters can be set using engineering units within the -100.0 to 100.0% range of that instrument.

Example: For an instrument range of -270.0°C to 1370.0°C,

- EU (0.0%) is -270.0°C.
- EU (100.0%) is 1370.0°C.
- EU (-100.0%) is -1910.0°C.

Thus, EU (-100.0 to 100.0%) indicates a temperature range of -1910.0°C to 1370.0°C.

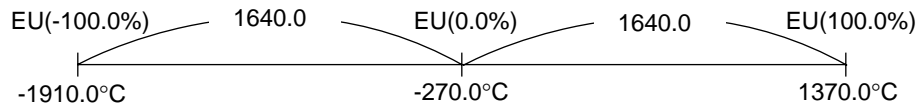

■ EUS

“EUS” is the engineering unit indicating the span of the instrument range. Use “EUS” to set a bias or deviation alarm setpoint.

The notation, “EUS (-100.0 to 100.0%),” is used for the range of settings that can be set for each of the parameters listed in appendices 2 and 3. That is, parameters can be set using engineering units within the -100.0 to 100.0% range of the instrument span.

Example: For an instrument range of -270.0°C to 1370.0°C,

- The instrument span is 1640.0°C.
- EUS (0.0%) is 0.0°C.
- EUS (100.0%) is 1640.0°C.
- EUS (-100.0%) is -1640.0°C.

Thus, EUS (-100.0 to 100.0%) indicates a temperature span of -1640.0°C to 1640.0°C.

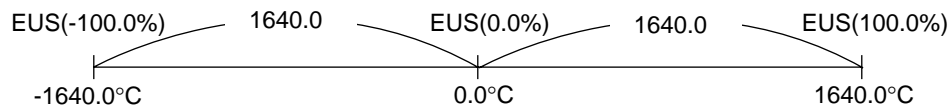

Blank Page

Appendix 3 Operation Parameter Table

The following tables list all the US1000 parameters. Some parameters are hidden (i.e., unavailable) depending on the model names or controller modes (US modes).

■ Table notations

- Main:** Contains the code indications corresponding to the parameters in the main menu.
Sub: Contains the code indications corresponding to the parameters in the submenu.
Parameter: Contains the parameter code indications.
Setting range: Range of parameter settings or options
Default: Value set when shipped
Setpoint: Column for customer to note customized setpoint
EU*: Engineering unit corresponding to instrument range
EUS*: Engineering unit corresponding to instrument span
 *Refer to “Appendix 2” for details of EU and EUS.

■ Mode Menu

Main	Sub	Parameter	Description	Setting Range	Default	Setpoint
MODE	—	O/C	OPEN/CLOSE switchover	CLOSE/OPEN	CLOSE	
		SVNO	SV number selection	1 to 8	1	

■ Loop-1 Operation Menu: Computation Parameter Submenu

Main	Sub	Parameter	Description	Setting Range	Default	Setpoint
0.LP1	PAR	AT	Auto-tuning selection	OFF, 1 to 8: Individual execution among PID groups, 9: Collective execution for 1 to 8 PID groups. When PPID parameter is set at 0: OFF or 1.	OFF	
		SC	SUPER function selection	OFF, ON	OFF	
		BS	PV bias	EUS (-100.0 to 100.0%)	EUS (0%)	
		FL	PV filter	OFF, 1 to 120 s	OFF	
		UPR	Setpoint ramp-up	OFF, EUS (0.1 to 100.0%)	OFF	
		DNR	Setpoint ramp-down	OFF, EUS (0.1 to 100.0%)	OFF	
		CRT	Cascade ratio	0.001 to 9.999	1.000	
		CBS	Cascade bias	EUS (-100.0 to 100.0%)	EUS (0%)	
		CFL	Cascade input filter	OFF, 1 to 120 s	OFF	
		FGN	Feedforward gain	-9.999 to 9.999	1.000	
		FBI	Feedforward input bias	-100.0 to 100.0%	0.0%	
		FBO	Feedforward output bias	-999.9 to 999.9%	0.0%	
FFL	Feedforward input filter	OFF, 1 to 120 s	OFF			

■ Loop-1 Operation Menu: 1.PID to 8.PID Submenus

When using more than one PID parameter, duplicate the following list by the required number and record the setpoint values.

Main	Sub	Parameter	Description	Setting Range	Default	Setpoint
0.LP1	n.PID n=1-8	n.SV	Target setpoint	EU (0.0 to 100.0%)	EU (0%)	
		n.A1	Alarm 1 setpoint	PV alarm: EU (-100.0 to 100.0%) Deviation alarm/PV-velocity alarm: EUS(-100.0 to 100.0%) SV alarm: EU (0.0 to 100.0%) MV alarm: -5.0 to 105.0%	PV high limit: EU (100.0%) Deviation alarm: EUS (0.0%) MV high limit: 100.0% MV low limit: 0.0% PV velocity: EUS (100.0%) Other alarms: EU (0.0%)	
		n.A2	Alarm 2 setpoint			
		n.A3	Alarm 3 setpoint			
		n.A4	Alarm 4 setpoint			
		n.P	Proportional band	0.1 to 999.9%, 0.0 to 999.9% for heating/cooling computation	999.9%	
		n.I	Integral time	OFF, 1 to 6000 s	1000 s	
		n.D	Derivative time	OFF, 1 to 6000 s	OFF	
		n.MH	Upper limit of output	n.ML +0.1% to 105.0%; 0.0 to 105.0% for heating-side output limit in heating/cooling computation	100.0%	
		n.ML	Lower limit of output	-5.0 % to n.MH - 0.1%; 0.0 to 105.0% for cooling-side output limit in heating/cooling computation	0.0%; heating/cooling computation: 100.0%	
		n.MR	Manual reset	-5.0 to 105.0%	50.0%	
		n.H	Hysteresis	ON/OFF computation: EUS (0.0 to 100.0%), Position proportional PID or heating/cooling computation: 0.0 to 100.0%	ON/OFF computation: EUS (0.5%), Position proportional PID or heating/cooling computation: 0.5%	
		n.DR	Direct/reverse action switchover	0: Reverse action; 1: Direct action	0	
		n.Pc	Cooling-side proportional band	0.0 to 999.9%	999.9%	
		n.Ic	Cooling-side integral time	OFF, 1 to 6000 s	1000 s	
		n.Dc	Cooling-side derivative time	OFF, 1 to 6000 s	OFF	
		n.Hc	Cooling-side relay hysteresis	0.0 to 100.0%	0.5%	
	n.DB	Deadband	Heating/cooling computation: -100.0 to 50.0% Position proportional PID computation: 1.0 to 10.0%	3.0%		
	m.PID m=1-6	m.RP	Zone PID reference point	EU (0.0 to 100.0%) provided that 1.RP≤2.RP≤3.RP≤4.RP≤5.RP≤6.RP	EU (100.0%)	
	7.PID	RHY	Zone PID hysteresis	EUS (0.0 to 10.0%)	EUS (0.5%)	
	8.PID	RDV	Zone PID reference deviation	OFF, EUS (0.0 to 100.0%)	OFF	
	n.PID n=1-8	n.PM	Preset MV	-5.0 to 105.0%	-5.0%	
		n.PMc	Cooling-side preset MV	-5.0 to 105.0%	0.0%	

■ Loop-2 Operation Menu: Computation Parameter Submenu

Main	Sub	Parameter	Description	Setting Range	Default	Setpoint
0.LP2	PAR	AT	Auto-tuning selection	OFF, 1 to 8: Individual execution among PID groups, 9: Collective execution for 1 to 8 PID groups. When PPID parameter is set at 0: OFF or 1.	OFF	
		SC	SUPER function selection	OFF, ON	OFF	
		BS	PV bias	EUS (-100.0 to 100.0%)	EUS (0%)	
		FL	PV filter	OFF, 1 to 120 s	OFF	
		UPR	Setpoint ramp-up	OFF, EUS (0.1 to 100.0%)	OFF	
		DNR	Setpoint ramp-down	OFF, EUS (0.1 to 100.0%)	OFF	
		CRT	Cascade ratio	0.001 to 9.999	1.000	
		CBS	Cascade bias	EUS (-100.0 to 100.0%)	EUS (0%)	
		CFL	Cascade input filter	OFF, 1 to 120 s	OFF	

To be continued

■ Loop-2 Operation Menu: 1.PID to 8.PID Submenus

Main	Sub	Parameter	Description	Setting Range	Default	Setpoint
0.LP2	n.PID n=1-8	n.SV	Target setpoint	EU (0.0 to 100.0%)	EU (0%)	
		n.A1	Alarm 1 setpoint	PV alarm: EU (-100.0 to 100.0%) Deviation alarm/PV-velocity alarm: EUS(-100.0 to 100.0%) SV alarm: EU (0.0 to 100.0%) MV alarm: -5.0 to 105.0%	PV high limit: EU (100.0%) Deviation alarm: EUS (0.0%) MV high limit: 100.0% MV low limit: 0.0% PV velocity: EUS (100.0%) Other alarms: EU (0.0%)	
		n.A2	Alarm 2 setpoint			
		n.A3	Alarm 3 setpoint			
		n.A4	Alarm 4 setpoint			
		n.P	Proportional band	0.1 to 999.9%, 0.0 to 999.9% for heating/cooling computation	999.9%	
		n.I	Integral time	OFF, 1 to 6000 s	1000 s	
		n.D	Derivative time	OFF, 1 to 6000 s	OFF	
		n.MH	Upper limit of output	n.ML +0.1% to 105.0%; 0.0 to 105.0% for heating-side output limit in heating/cooling computation	100.0%	
		n.ML	Lower limit of output	-5.0 % to n.MH - 0.1%; 0.0 to 105.0% for cooling-side output limit in heating/cooling computation	0.0%; heating/cooling computation: 100.0%	
		n.MR	Manual reset	-5.0 to 105.0%	50.0%	
		n.H	Hysteresis	ON/OFF computation: EUS (0.0 to 100.0%), Position proportional PID or heating/cooling computation: 0.0 to 100.0%	ON/OFF computation: EUS (0.5%), Position proportional PID or heating/cooling computation: 0.5%	
		n.DR	Direct/reverse action switchover	0: Reverse action; 1: Direct action	0	
		n.Pc	Cooling-side proportional band	0.0 to 999.9%	999.9%	
		n.Ic	Cooling-side integral time	OFF, 1 to 6000 s	1000 s	
		n.Dc	Cooling-side derivative time	OFF, 1 to 6000 s	OFF	
		n.Hc	Cooling-side relay hysteresis	0.0 to 100.0%	0.5%	
		n.DB	Deadband	Heating/cooling computation: -100.0 to 50.0% Position proportional PID computation: 1.0 to 10.0%	3.0%	
	m.PID m=1-6	m.RP	Zone PID reference point	EU (0.0 to 100.0%) provided that 1.RP≤2.RP≤3.RP≤4.RP≤5.RP≤6.RP	EU (100.0%)	
	7.PID	RHY	Zone PID hysteresis	EUS (0.0 to 10.0%)	EUS (0.5%)	
	8.PID	RDV	Zone PID reference deviation	OFF, EUS (0.0 to 100.0%)	OFF	
	n.PID n=1-8	n.PM	Preset MV	-5.0 to 105.0%	-5.0%	
	n.PMc	Cooling-side preset MV	-5.0 to 105.0%	0.0%		

■ USER Parameter Menu

Main	Sub	Parameter	Description	Setting Range	Default	Setpoint
USR	-	UI	USER parameter 1	-19999 to 31500	Refer to the following.	
		U2	USER parameter 2	-19999 to 31500	0	
		U3	USER parameter 3	-19999 to 31500	0	
		U4	USER parameter 4	-19999 to 31500	0	
		U5	USER parameter 5	-19999 to 31500	0	
		U6	USER parameter 6	-19999 to 31500	0	
		U7	USER parameter 7	-19999 to 31500	0	
		U8	USER parameter 8	-19999 to 31500	0	

- **US mode = Loop control with PV switching (USM = 6), and
US mode = Loop control with PV auto-selector and two universal inputs (USM = 14)**
 - U1: PV upper limit for PV switching (Default = 0)
 - U2: PV lower limit for PV switching (Default = 0)
 - U3: Switching condition (Default = 0)
 - U3 = 0: Switching within the PV range specified by U1 and U2
 - U3 = 1: Switching at the PV upper limit specified by U1
 - U3 = 2: Switching by contact input
- **US mode = Loop control with PV auto-selector (USM = 7)**
 - U1: Input selection (Default = 2)
 - U1 = 0: Accepts the maximum value between inputs 1 and 2
 - U1 = 1: Accepts the minimum value between inputs 1 and 2
 - U1 = 2: Accepts the average value of inputs 1 and 2
 - U1 = 3: Accepts the difference between inputs 1 and 2 (input 2 - input 1)
- **US mode = Loop control with PV auto-selector and two universal inputs (USM = 15)**
 - U1: Input selection (Default = 2)
 - U1 = 0: Accepts the maximum value between input 1, input 2 (and input 3)
 - U1 = 1: Accepts the minimum value between input 1, input 2 (and input 3)
 - U1 = 2: Accepts the average value of input 1, input 2 (and input 3)
 - U1 = 3: Accepts the difference between inputs 1 and (input 2 - input 1)
 - U2: Number of inputs (Default = 0)
 - U2 = 0: Uses two points (inputs 1 and 2)
 - U2 = 1: Uses three points (inputs 1, 2 and 3)

■ Ten-segment Linearizer-1 Menu

To change the setting range and unit for ten-segment linearizer 1, edit the PY1X and PY1Y parameters from the Ten-segment Linearizer Unit submenu (C.PYS). If they are not edited, the following default values are assumed:

Main	Sub	Parameter	Description	Setting Range	Default	Setpoint
PYS1	-	1. X1	Ten-segment linearizer-1 input 1	EU (-66.7 to 105.0%)	EU (0.0%)	
		1. Y1	Ten-segment linearizer-1 output 1	EUS (-66.7 to 105.0%)	EUS (0.0%)	
		1. X2	Ten-segment linearizer-1 input 2	EU (-66.7 to 105.0%)	EU (0.0%)	
		1. Y2	Ten-segment linearizer-1 output 2	EUS (-66.7 to 105.0%)	EUS (0.0%)	
		1. X3	Ten-segment linearizer-1 input 3	EU (-66.7 to 105.0%)	EU (0.0%)	
		1. Y3	Ten-segment linearizer-1 output 3	EUS (-66.7 to 105.0%)	EUS (0.0%)	
		1. X4	Ten-segment linearizer-1 input 4	EU (-66.7 to 105.0%)	EU (0.0%)	
		1. Y4	Ten-segment linearizer-1 output 4	EUS (-66.7 to 105.0%)	EUS (0.0%)	
		1. X5	Ten-segment linearizer-1 input 5	EU (-66.7 to 105.0%)	EU (0.0%)	
		1. Y5	Ten-segment linearizer-1 output 5	EUS (-66.7 to 105.0%)	EUS (0.0%)	
		1. X6	Ten-segment linearizer-1 input 6	EU (-66.7 to 105.0%)	EU (0.0%)	
		1. Y6	Ten-segment linearizer-1 output 6	EUS (-66.7 to 105.0%)	EUS (0.0%)	
		1. X7	Ten-segment linearizer-1 input 7	EU (-66.7 to 105.0%)	EU (0.0%)	
		1. Y7	Ten-segment linearizer-1 output 7	EUS (-66.7 to 105.0%)	EUS (0.0%)	
		1. X8	Ten-segment linearizer-1 input 8	EU (-66.7 to 105.0%)	EU (0.0%)	
		1. Y8	Ten-segment linearizer-1 output 8	EUS (-66.7 to 105.0%)	EUS (0.0%)	
		1. X9	Ten-segment linearizer-1 input 9	EU (-66.7 to 105.0%)	EU (0.0%)	
		1. Y9	Ten-segment linearizer-1 output 9	EUS (-66.7 to 105.0%)	EUS (0.0%)	
		1. X10	Ten-segment linearizer-1 input 10	EU (-66.7 to 105.0%)	EU (0.0%)	
		1. Y10	Ten-segment linearizer-1 output 10	EUS (-66.7 to 105.0%)	EUS (0.0%)	
		1. X11	Ten-segment linearizer-1 input 11	EU (-66.7 to 105.0%)	EU (0.0%)	
1. Y11	Ten-segment linearizer-1 output 11	EUS (-66.7 to 105.0%)	EUS (0.0%)			
		1. PMD	Ten-segment linearizer-1 mode	0: Biasing; 1: Approximation	0	

■ Ten-segment Linearizer-2 Menu

To change the setting range and unit for the ten-segment linearizer 2, edit the PY2X and PY2Y parameters from the Ten-segment Linearizer Unit submenu (C.PYS). If they are not edited, the following default values are assumed:

Main	Sub	Parameter	Description	Setting Range	Default	Setpoint
PYS2	-	2. X1	Ten-segment linearizer-2 input 1	EU (-66.7 to 105.0%)	EU (0.0%)	
		2. Y1	Ten-segment linearizer-2 output 1	EUS (-66.7 to 105.0%)	EUS (0.0%)	
		2. X2	Ten-segment linearizer-2 input 2	EU (-66.7 to 105.0%)	EU (0.0%)	
		2. Y2	Ten-segment linearizer-2 output 2	EUS (-66.7 to 105.0%)	EUS (0.0%)	
		2. X3	Ten-segment linearizer-2 input 3	EU (-66.7 to 105.0%)	EU (0.0%)	
		2. Y3	Ten-segment linearizer-2 output 3	EUS (-66.7 to 105.0%)	EUS (0.0%)	
		2. X4	Ten-segment linearizer-2 input 4	EU (-66.7 to 105.0%)	EU (0.0%)	
		2. Y4	Ten-segment linearizer-2 output 4	EUS (-66.7 to 105.0%)	EUS (0.0%)	
		2. X5	Ten-segment linearizer-2 input 5	EU (-66.7 to 105.0%)	EU (0.0%)	
		2. Y5	Ten-segment linearizer-2 output 5	EUS (-66.7 to 105.0%)	EUS (0.0%)	
		2. X6	Ten-segment linearizer-2 input 6	EU (-66.7 to 105.0%)	EU (0.0%)	
		2. Y6	Ten-segment linearizer-2 output 6	EUS (-66.7 to 105.0%)	EUS (0.0%)	
		2. X7	Ten-segment linearizer-2 input 7	EU (-66.7 to 105.0%)	EU (0.0%)	
		2. Y7	Ten-segment linearizer-2 output 7	EUS (-66.7 to 105.0%)	EUS (0.0%)	
		2. X8	Ten-segment linearizer-2 input 8	EU (-66.7 to 105.0%)	EU (0.0%)	
		2. Y8	Ten-segment linearizer-2 output 8	EUS (-66.7 to 105.0%)	EUS (0.0%)	
		2. X9	Ten-segment linearizer-2 input 9	EU (-66.7 to 105.0%)	EU (0.0%)	
		2. Y9	Ten-segment linearizer-2 output 9	EUS (-66.7 to 105.0%)	EUS (0.0%)	
		2. X10	Ten-segment linearizer-2 input 10	EU (-66.7 to 105.0%)	EU (0.0%)	
		2. Y10	Ten-segment linearizer-2 output 10	EUS (-66.7 to 105.0%)	EUS (0.0%)	
2. X11	Ten-segment linearizer-2 input 11	EU (-66.7 to 105.0%)	EU (0.0%)			
2. Y11	Ten-segment linearizer-2 output 11	EUS (-66.7 to 105.0%)	EUS (0.0%)			
		2. PMD	Ten-segment linearizer-2 mode	0: Biasing; 1: Approximation	0	

■ Setup Parameter Menu

Main	Sub	Parameter	Description	Setting Range	Default	Setpoint
STUP	-	PS. IN	Password input	0 to 30000	0	

Blank Page

Appendix 4 Setup Parameter Table

Some parameters are hidden (i.e., unavailable) depending on the model names or controller modes (US modes).

■ Table notations

Main: Contains the code indications corresponding to the parameters in the main menu.

Sub: Contains the code indications corresponding to the parameters in the submenu.

Parameter: Contains the parameter code indications.

Setting range: Range of parameter settings or options

Default: Value set when shipped

Setpoint: Column for customer to note customized setpoint

EU *: Engineering unit corresponding to instrument range

EUS *: Engineering unit corresponding to instrument span

*: Refer to “Appendix 2” for details of EU and EUS.

■ Single-loop Setup Menu: Target Setpoint Submenu

Main	Sub	Parameter	Description	Setting Range	Default	Setpoint
S.LP1	SV	CMS	Cascade input selection	AIN: Analog input CPT: Communication	AIN	
		PVT	PV tracking selection	OFF, ON	OFF	
		TMU	Time unit for ramp-rate setting	0: 1 h; 1: 1 min	0	
		DVB	Deviation display range	EUS (0.0 to 100.0%)	EUS (1.65%)	

■ Single-loop Setup menu: Alarm Setting Submenu

Main	Sub	Parameter	Description	Setting Range	Default	Setpoint
S.LP1	ALM	AL1	Alarm 1 type	OFF, 1 to 29 (see section 4.7)	1	
		AL2	Alarm 2 type	OFF, 1 to 29 (see section 4.7)	2	
		AL3	Alarm 3 type	OFF, 1 to 29 (see section 4.7)	1	
		AL4	Alarm 4 type	OFF, 1 to 29 (see section 4.7)	2	
		HY1	Alarm 1 hysteresis	EUS (0.0 to 100.0%), MV alarm: 0.0 to 100.0%	EUS (0.5%), MV alarm: 0.5%	
		HY2	Alarm 2 hysteresis			
		HY3	Alarm 3 hysteresis			
		HY4	Alarm 4 hysteresis			
		PVR.T	PV velocity alarm duration time	1 to 9999 s	1 sec.	
		AMD	Alarm mode	0: Always enabled 1: Disabled in STOP mode 2: Disabled in STOP or MAN mode 3: 8 alarms & always enabled 4: 8 alarms & disabled in STOP mode 5: 8 alarms & disabled in STOP or MAN mode	0	

■ Loop-1 Setup Menu: Control Function Submenu

Main	Sub	Parameter	Description	Setting Range	Default	Setpoint
S.LP1	CTL	MVR	Output velocity limiter	OFF, 0.1 to 100.0%/s	OFF	
		MOD	PID control mode	0: Batch control; 1: Fixed point control	1	
		AR	Anti-reset windup	AUTO; 50.0 to 200.0%	AUTO	
		FFS	Feedforward input selection	OFF = Disabled; AIN: Analog input	OFF	

■ Loop-2 Setup Menu: Target Setpoint Submenu

Main	Sub	Parameter	Description	Setting Range	Default	Setpoint
S.LP2	SV	CMS	Cascade input selection	AIN: Analog input; CPT: Communication	AIN	
		PVT	PV tracking selection	OFF, ON	OFF	
		TMU	Time unit for ramp-rate setting	0: 1 h; 1: 1 min	0	
		DVB	Deviation display range	EUS (0.0 to 100.0%)	EUS (1.65%)	

■ Loop-2 Setup Menu: Alarm Setting Submenu

Main	Sub	Parameter	Description	Setting Range	Default	Setpoint
S.LP2	ALM	AL1	Alarm 1 type	OFF, 1 to 29 (see section 4.7)	1	
		AL2	Alarm 2 type	OFF, 1 to 29 (see section 4.7)	2	
		AL3	Alarm 3 type	OFF, 1 to 29 (see section 4.7)	1	
		AL4	Alarm 4 type	OFF, 1 to 29 (see section 4.7)	2	
		HY1	Alarm 1 hysteresis	EUS (0.0 to 100.0%), MV alarm: 0.0 to 100.0%	EUS (0.5%), MV alarm: 0.5%	
		HY2	Alarm 2 hysteresis			
		HY3	Alarm 3 hysteresis			
		HY4	Alarm 4 hysteresis			
		PVR.T	PV velocity alarm duration time	1 to 9999 s	1 s	
AMD	Alarm mode	0: Always enabled 1: Disabled in STOP mode 2: Disabled in STOP or MAN mode	0			

■ Loop-2 Setup Menu: Control Function Submenu

Main	Sub	Parameter	Description	Setting Range	Default	Setpoint
S.LP2	CTL	MVR	Output rate-of-change limiter	OFF, 0.1 to 100.0%/s	OFF	
		MOD	PID control mode	0: Batch control; 1: Fixed-point control	1	
		AR	Anti-reset windup	AUTO; 50.0 to 200.0%	AUTO	

■ Common Setup Menu: Analog Input Computation Submenu

Main	Sub	Parameter	Description	Setting Range	Default	Setpoint
CMPL	AIN	A.BS1	Analog input-1 bias	EUS (-100.0 to 100.0%)	EUS (0%)	
		A.FL1	Analog input-1 filter	OFF, 1 to 120 s	OFF	
		A.SR1	Analog input-1 square-root computation	OFF, ON	OFF	
		A.LC1	Analog input-1 square-root low signal cut off	0.0 to 5.0%	1.0%	
		A.BO1	Analog input-1 burnout action	OFF: Disabled UPS: Upscale DNS: Downscale	OFF	
		A.RI1	Analog input-1 reference junction compensation	OFF, ON	ON	
		A.BS2	Analog input-2 bias	EUS (-100.0 to 100.0%)	EUS (0%)	
		A.FL2	Analog input-2 filter	OFF, 1 to 120 s	OFF	
		A.SR2	Analog input-2 square-root computation	OFF, ON	OFF	
		A.LC2	Analog input-2 square-root low signal cut off	0.0 to 5.0%	1.0%	
		A.BO2	Analog input-2 burnout action	OFF: Disabled UPS: Upscale DNS: Downscale	OFF	
		A.RJ2	Analog input-2 reference junction compensation	OFF, ON	ON	
		A.BS3	Analog input-3 bias	EUS (-100.0 to 100.0%)	EUS (0%)	
		A.FL3	Analog input-3 filter	OFF, 1 to 120 s	OFF	
		A.SR3	Analog input-3 square-root computation	OFF, ON	OFF	
A.LC3	Analog input-3 square-root low signal cut off	0.0 to 5.0%	1.0%			
A.BO3	Analog input-3 burnout action	OFF: Disabled UPS: Upscale DNS: Downscale	OFF			

■ Common Setup Menu: Common Control Function Submenu

Main	Sub	Parameter	Description	Setting Range	Default	Setpoint
CMLP	C.CTL	PPID	Preset PID function selection	0: Disabled Preset PID 1: SV number selection 2: Zone PID	0	
		R.MD	Restart mode	HOT: Continues the operation prior to power failure COLD: Starts in MAN mode	COLD	
		R.TM	Restart timer	0 to 60 s	0 s	
		CT1	Cycle time of MV1	1 to 1000 s	30 s	
		CT2	Cycle time of MV2	1 to 1000 s	30 s	
		CTc1	Cycle time of cooling side MV1	1 to 1000 s	30 s	
		CTc2	Cycle time of cooling side MV2	1 to 1000 s	30 s	

■ **Common Setup Menu: Retransmission Output Submenu**

Main	Sub	Parameter	Description	Setting Range	Default	Setpoint
CMLP	RET	RET1	Retransmission output-1 type	OFF: Disabled; 1: PV1; 2: SV1; 3: MV1; 4: PV2; 5: SV2; 6: MV2	3	
		RTH1	Maximum value of retransmission output-1 scale	RET1 = 1/2/4/5: RTL1 + 1 digit to EU (100.0%) *1 RET1 = 3/6: RTL1 + 1 digit to 100.0% *1	100.0	
		RTL1	Minimum value of retransmission output-1 scale	RET1 = 1/2/4/5: EU (0.0%) to RTH1 - 1 digit *1 RET1 = 3/6: 0.0% to RTH1 - 1 digit *1	0.0	
		RET2	Retransmission output-2 type	OFF: Disabled; 1: PV1; 2: SV1; 3: MV1; 4: PV2; 5: SV2; 6: MV2	2	
		RTH2	Maximum value of retransmission output-2 scale	RET2 = 1/2/4/5: RTL2 + 1 digit to EU (100.0%) *1 RET2 = 3/6: RTL2 + 1 digit to 100.0% *1	P.RH1	
		RTL2	Minimum value of retransmission output-2 scale	RET2 = 1/2/4/5: EU (0.0%) to RTH2 - 1 digit *1 RET2 = 3/6: 0.0% to RTH2 - 1 digit *1	P.RL1	
		RET3	Retransmission output-3 type	OFF: Disabled; 1: PV1, 2: SV1, 3: MV1, 4: PV2, 5: SV2, 6: MV2	1	
		RTH3	Maximum value of retransmission output-3 scale	RET3 = 1/2/4/5: RTL3 + 1 digit to EU (100.0%) *1 RET3 = 3/6: RTL3 + 1 digit to 100.0% *1	P.RH1	
		RTL3	Minimum value of retransmission output-3 scale	RET3 = 1/2/4/5: EU (0.0%) to RTH3 - 1 digit *1 RET3 = 3/6: 0.0% to RTH3 - 1 digit *1	P.RL1	

*1: A “+1 digit” denotes a value with one digit added to the rightmost digit of an engineering unit. A “-1 digit” denotes a value with one digit subtracted from the rightmost digit of an engineering unit. For example, if RTL1 is 15.0°C, then RTL1 + 1 digit equals 15.1°C.

■ **Common Setup Menu: Key Lock Submenu**

Main	Sub	Parameter	Description	Setting Range	Default	Setpoint
CMLP	KLCK	SVC	SV setting key lock on operation displays	OFF, ON	OFF	
		△ / ▽	Data setting key lock	OFF, ON	OFF	
		< / >	MV operation key lock	OFF, ON	OFF	
		C	C mode key lock	OFF, ON	ON	
		A	A mode key lock	OFF, ON	OFF	
		M	M mode key lock	OFF, ON	OFF	

■ **Common Setup Menu: Menu Lock Submenu**

Main	Sub	Parameter	Description	Setting Range	Default	Setpoint
CMLP	MLCK	MODE	Mode menu lock	OFF, ON	OFF	
		0.LPI	0.LPI menu lock	OFF, ON	OFF	
		0.LP2	0.LP2 menu lock	OFF, ON	ON	
		PID	PID menu lock	OFF, ON	OFF	
		USR	USR menu lock	OFF, ON	ON	
		PYS1	PYS1 menu lock	OFF, ON	OFF	
		PYS2	PYS2 menu lock	OFF, ON	ON	
		PWD	Password setting	0: No password, 1 to 30000	0	

■ Common Setup Menu: RS-485 Submenu

Main	Sub	Parameter	Description	Setting Range	Default	Setpoint
CMLP	R485	PSL	Protocol selection	0: Modbus (ASCII), 1: Modbus (RTU), 2: PC-link communication, 3: PC-link communication with sum check	0	
		BPS	Baud rate	600, 1200, 2400,4800,9600, 19200, 38400 bps	9600	
		PARI	Parity	N: None, E: Even, O: Odd	E	
		STP	Stop bit	1, 2	1	
		DLN	Data length	7, 8	8	
		ADR	Controller address	1 to 99	1	
		RSP.T	Minimum response time	0 to 10 (x 10 ms)	0	

■ Detailed Function Setting Menu: SELECT Display Setting Submenu

Main	Sub	Parameter	Description	Setting Range	Default	Setpoint
CONF	C. SEL	C.S1	Registration for the SELECT display 1	OFF, 201 to 773 (see section 5.3)	OFF	
		C.S2	Registration for the SELECT display 2			
		C.S3	Registration for the SELECT display 3			
		C.S4	Registration for the SELECT display 4			
		C.S5	Registration for the SELECT display 5			

■ Detailed Function Setting Menu: USER Display Submenu

Main	Sub	Parameter	Description	Setting Range	Default	Setpoint
CONF	U. OPE	U.1AL	USER display of loop-1 alarm	OFF, ON	OFF	
		U.2AL	USER display of loop-2 alarm	OFF, ON	OFF	
		U.SVN	USER display of SV number	OFF, ON	OFF	
		U.1PI	USER display of loop-1 PID group number	OFF, ON	OFF	
		U.2PI	USER display of loop-2 PID group number	OFF, ON	OFF	
		U.AI1	USER display of AIN1 measured value	OFF, ON	OFF	
		U.AI2	USER display of AIN2 measured value	OFF, ON	OFF	
		U.AI3	USER display of AIN3 measured value	OFF, ON	OFF	
		U.PV1	USER display of PV1	OFF, ON	OFF	
		U.PV2	USER display of PV2	OFF, ON	OFF	
U.SMP	USER display of sampling error counter	OFF, ON	OFF			

■ Detailed Function Setting Menu: Contact Output Submenu

Main	Sub	Parameter	Description	Setting Range	Default	Setpoint
COMF	DO	DO1	Relay output flag registration for DO1	Set the functions (D register or I relay number). 0: Not registered 1 to 1700: D register 5001 to 7048: I relay Example: Loop-1 alarm output 1 = 5689 Loop-1 alarm output 2 = 5690 Loop-1 alarm output 3 = 5691 Loop-1 alarm output 4 = 5693 Loop-2 alarm output 1 = 5697 Loop-2 alarm output 2 = 5698 Loop-2 alarm output 3 = 5699 Loop-2 alarm output 4 = 5701	Depends on USM parameter	
		DO2	Relay output flag registration for DO2			
		DO3	Relay output flag registration for DO3			
		DO4	Transistor output flag registration for DO4			
		DO5	Transistor output flag registration for DO5			
		DO6	Transistor output flag registration for DO6			
		DO7	Transistor output flag registration for DO7			

■ Detailed Function Setting Menu: Contact Input Submenu

Main	Sub	Parameter	Description	Setting Range	Default	Setpoint
CONF	DI	CAS1	Loop-1 mode switchover to CAS when the DI changes to on	Set the functions (D register or I relay number). 0: Not registered 1 to 1700: D register 5001 to 7048: I relay DI1: 5161; DI2: 5162; DI3: 5163; DI4: 5164; DI5: 5165; DI6: 5166; DI7: 5167	Depends on USM parameter	
		AUT1	Loop-1 mode switchover to AUTO when the DI changes to on			
		MAN1	Loop-1 mode switchover to MAN when the DI changes to on			
		CAS2	Loop-2 mode switchover to CAS when the DI changes to on			
		AUT2	Loop-2 mode switchover to AUTO when the DI changes to on			
		MAN2	Loop-2 mode switchover to MAN when the DI changes to on			
		O/C	OPEN(on)/CLOSE(off) switchover			
		R/S	RUN(off) /STOP(on) switchover			
		TRF1	Loop-1 tracking flag			
		TRF2	Loop-2 tracking flag			
		SV.B0	Bit-0 of SV number setting			
		SV.B1	Bit-1 of SV number setting			
		SV.B2	Bit-2 of SV number setting			
		SV.B3	Bit-3 of SV number setting			
		DP1	Operation display for interruption 1			
		DP2	Operation display for interruption 2			
		MG1	Interruptive message display 1			
		MG2	Interruptive message display 2			
MG3	Interruptive message display 3					
MG4	Interruptive message display 4					

■ Detailed Function Setting Menu: Ten-Segment Linearizer Unit Submenu

Main	Sub	Parameter	Description	Setting Range	Default	Setpoint
CONF	C. PYS	PY1X	Ten-segment linearizer-1 input unit	0: %, 1: ABS0, 2:ABS1, 3: ABS2, 4: ABS3, 5: ABS4, 6: EU (AIN1), 7: EUS (AIN1), 8: EU (AIN2), 9: EUS (AIN2), 10: EU (AIN3), 11: EUS (AIN3), 12: EU (PV1), 13: EUS (PV1), 14: EU (PV2), 15: EUS (PV2)	12	
		PY1Y	Ten-segment linearizer-1 output unit		13	
		PY2X	Ten-segment linearizer-2 input unit		14	
		PY2Y	Ten-segment linearizer-2 output unit		15	

■ Controller Function Setting Menu: Controller Mode Submenu

Main	Sub	Parameter	Description	Setting Range	Default	Setpoint
USMD	MD	USM	Controller mode (US mode)	See section 4.3	1	
		SMP	Control period	50, 100, 200, 500 ms	200	

To be continued

■ Controller Function Setting Menu: Analog Input Submenu

Main	Sub	Parameter	Description	Setting Range	Default	Setpoint
USMD	IN	TYP1	Analog input-1 type for AIN1 terminal	See section 4.4	41	
		UNI1	Analog input-1 unit	°C: Celsius; °F: Fahrenheit	°C	
		RH1	Maximum value of analog input-1 range	Within instrument input range	Maximum level of instrument range	
		RL1	Minimum value of analog input-1 range	Within instrument input range	Minimum level of instrument range	
		SDP1	Analog input-1 decimal point position	0 to 4 *1	1	
		SH1	Maximum value of analog input-1 scale	-19999 to 30000, SL1<SH1	100.0	
		SL1	Minimum value of analog input-1 scale	-19999 to 30000, SL1<SH1	0.0	
		TYP2	Analog input-2 type for AIN2 terminal	See section 4.4	41	
		UNI2	Analog input-2 unit	°C: Celsius; °F: Fahrenheit	°C	
		RH2	Maximum value of analog input-2 range	Within instrument input range	Maximum level of instrument range	
		RL2	Minimum value of analog input-2 range	Within instrument input range	Minimum level of instrument range	
		SDP2	Analog input-2 decimal point position	0 to 4 *1	1	
		SH2	Maximum value of analog input-2 scale	-19999 to 30000, SL2<SH2	100.0	
		SL2	Minimum value of analog input-2 scale	-19999 to 30000, SL2<SH2	0.0	
		TYP3	Analog input-3 type for AIN3 terminal	See section 4.4	41	
		RH3	Maximum value of analog input-3 range	Within instrument input range	5.000	
		RL3	Minimum value of analog input-3 range	Within instrument input range	1.000	
		SDP3	Analog input-3 decimal point position	0 to 4 *1	1	
		SH3	Maximum value of analog input-3 scale	-19999 to 30000, SL3<SH3	100.0	
		SL3	Minimum value of analog input-3 scale	-19999 to 30000, SL3<SH3	0.0	
		P.DP1	PV1 decimal point position	0 to 4 *1	1	
		P.RH1	Maximum value of PV1 range	-19999 to 30000, 0<P.RH1- P.RL1≤30000	Thermocouple, RTD: RH1 value; voltage input: 100.0	
		P.RL1	Minimum value of PV1 range	-19999 to 30000, 0<P.RH1- P.RL1≤30000	Thermocouple, RTD: RL1 value; voltage input: 0.0	
		P.DP2	PV2 decimal point position	0 to 4 *1	1	
P.RH2	Maximum value of PV2 range	-19999 to 30000, 0<P.RH2- P.RL2≤30000	Thermocouple, RTD: RH2 value; voltage input: 100.0			
P.RL2	Minimum value of PV2 range	-19999 to 30000, 0<P.RH2- P.RL2≤30000	Thermocouple, RTD: RL2 value; voltage input: 0.0			

*1: These setting ranges are displayed by underbars: ‘_’ and a period: ‘.’.

For example, the setting range is displayed like ‘_ _ _ . _’ when the decimal point position is 1.

■ Controller Function Setting Menu: MV Output Submenu

Main	Sub	Parameter	Description	Setting Range	Default	Setpoint
USMD	OUT	MVS1	MV1 selection	0: Control relay output, 1: Voltage pulse output, 2: Current output, 3: Control relay output for ON/OFF computation, 4 to 12: Output for heating/cooling computation (see below)	2	
		MVS2	MV2 selection		2	
		AO1	Analog output-1 type for OUT1A terminal	0: 4 to 20 mA; 1: 0 to 20 mA; 2: 20 to 4 mA; 3: 20 to 0 mA	0	
		AO2	Analog output-2 type for OUT2A terminal		0	
		AO3	Analog output-3 type for OUT3A terminal		0	
		RVOP	Reverse display and operation of MV	OFF, ON	OFF	

4: Heating control relay output • Cooling control relay output

5: Heating pulse output • Cooling control relay output

6: Heating current output • Cooling control relay output

7: Heating control relay output • Cooling pulse output

8: Heating pulse output • Cooling pulse output

9: Heating current output • Cooling pulse output

10: Heating control relay output • Cooling current output

11: Heating pulse output • Cooling current output

12: Heating current output • Cooling current output

* For dual-loop control and temperature and humidity control, see section 3.2.2.

■ Controller Function Setting Menu: Valve Calibration Submenu

Main	Sub	Parameter	Description	Setting Range	Default	Setpoint
USMD	VALV	V.RS	Reset valve position	0, 1; Setting 1 clears valve position data.	0	
		V.L	Valve in fully-closed position	The position data of a fully-closed valve is saved when the SET/ENT key is pressed after a valve is fully closed using the ▽ key.	Indefinite	
		V.H	Valve in fully-opened position	The position data of a fully-opened valve is saved when the SET/ENT key is pressed after a valve is fully opened using the △ key.	Indefinite	
		V.AT	Automatic calibration for valve positioning	OFF, ON	OFF	

■ Controller Function Menu: Parameter Initialization Submenu

Main	Sub	Parameter	Description	Setting Range	Default	Setpoint
USMD	INIT	INIT	Parameter initialization	OFF, ON	OFF	

■ Controller Function Menu: Test Mode Submenu

Main	Sub	Parameter	Description	Setting Range	Default	Setpoint
USMD	TEST	TST	Test mode	Do not use this mode.	–	

Blank Page

Appendix 5 Parameter Map

The parameter maps help you retrieve the desired parameters by showing the individual configuration diagrams for the operation and setup parameter groups. Make use of this appendix together with parameter tables given in appendices 3 and 4 when setting parameters.

Some parameters are hidden (i.e., unavailable) depending on the model names or controller modes (US modes).

■ Operating Parameters

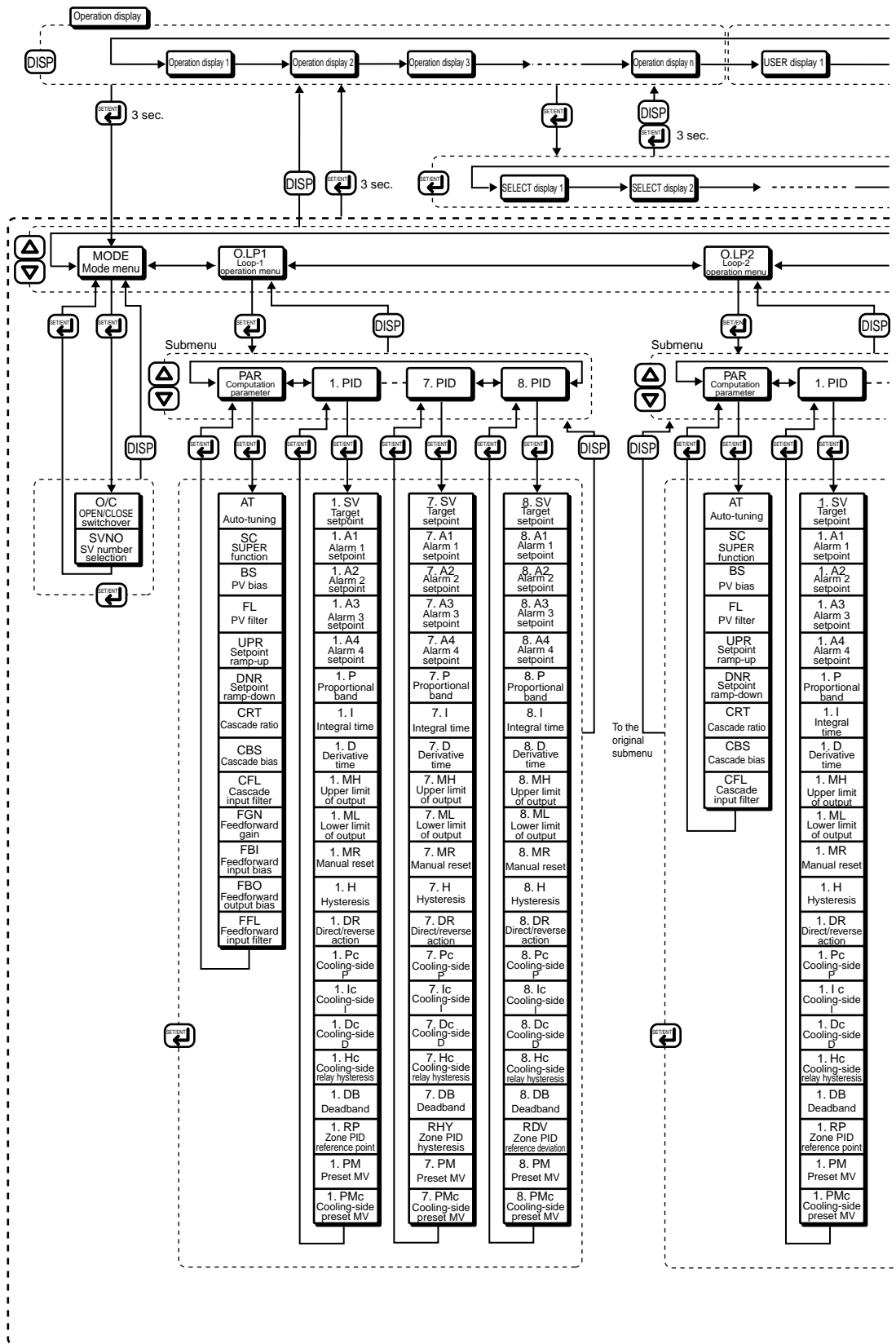

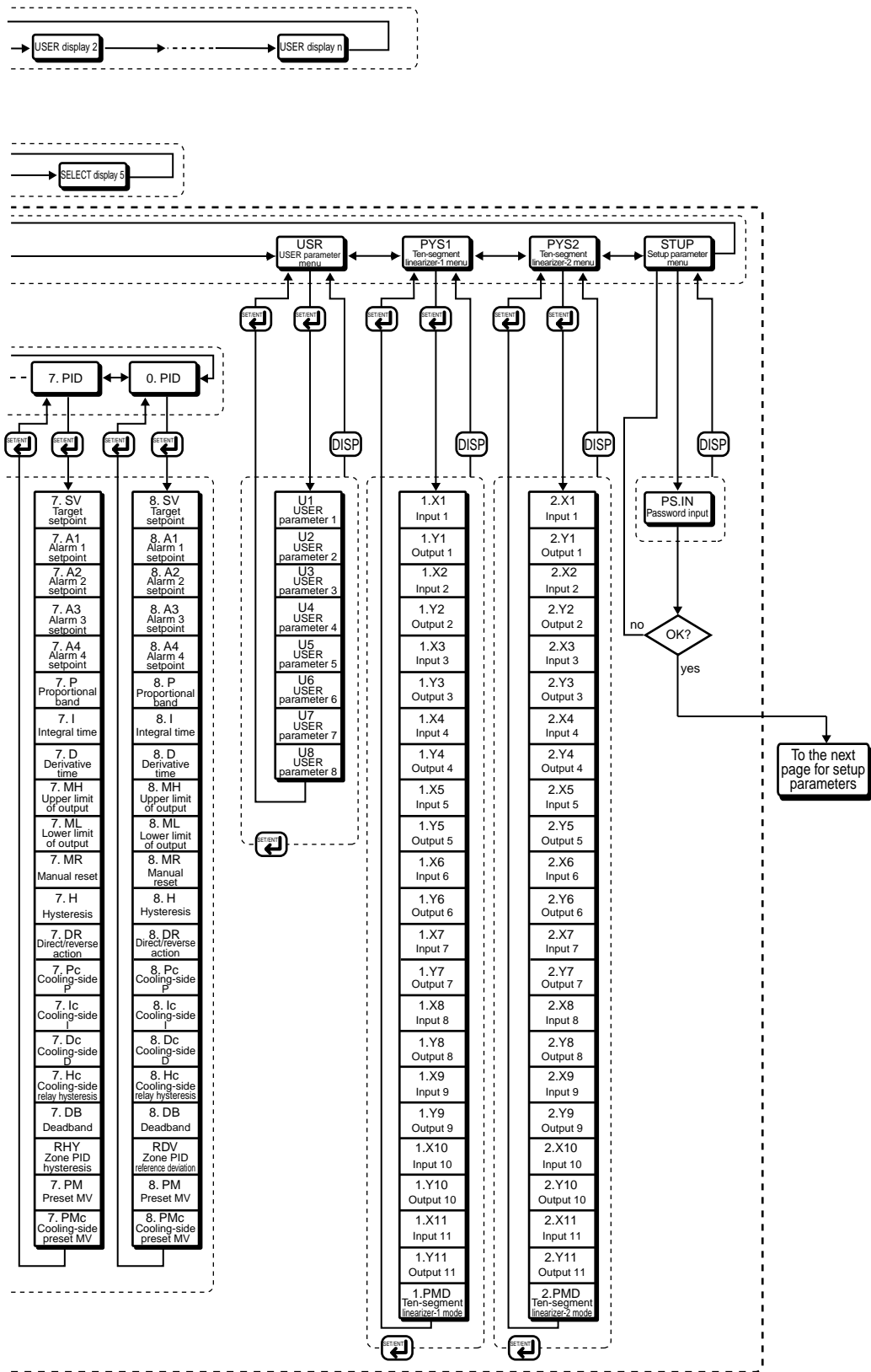

■ Setup Parameters

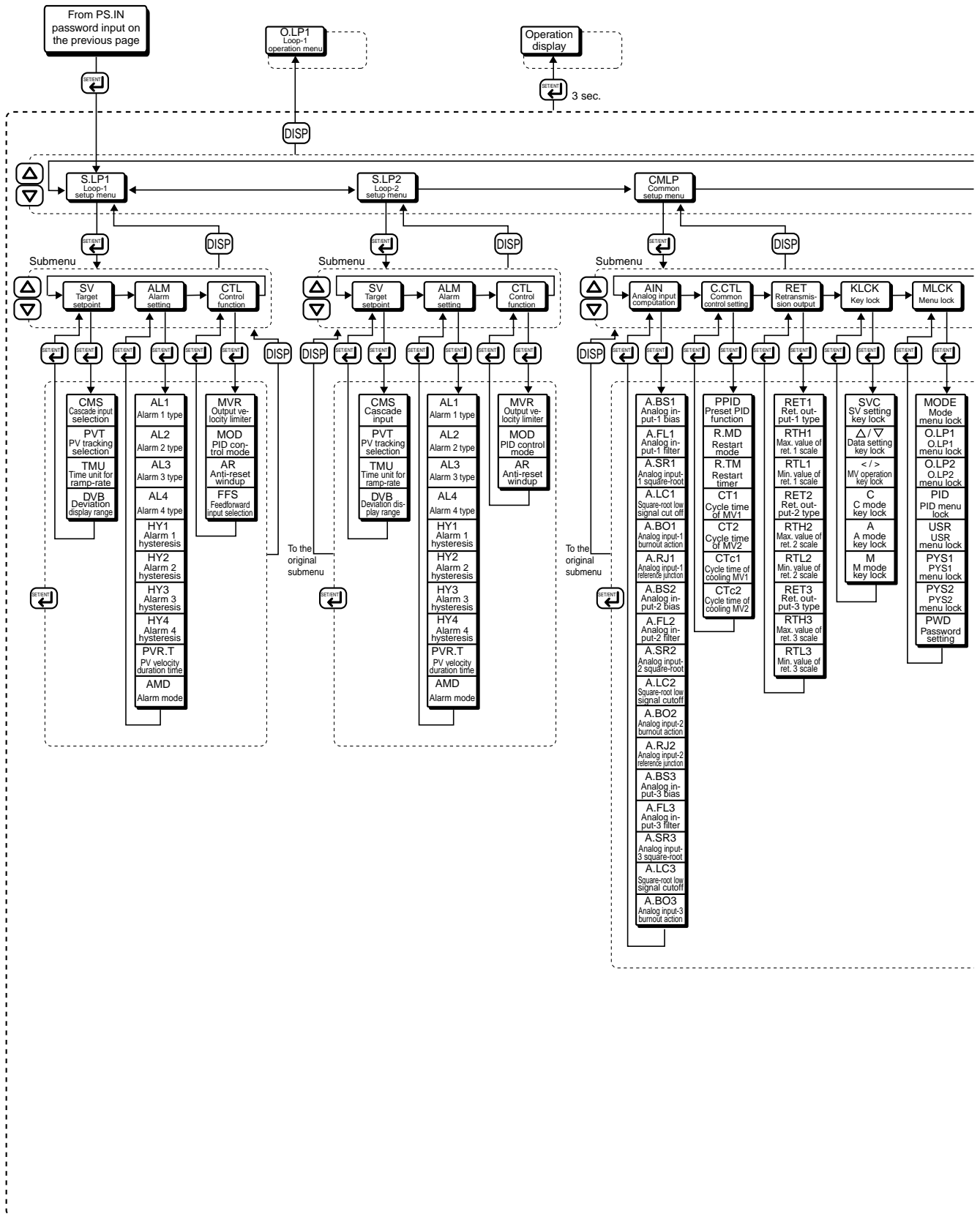

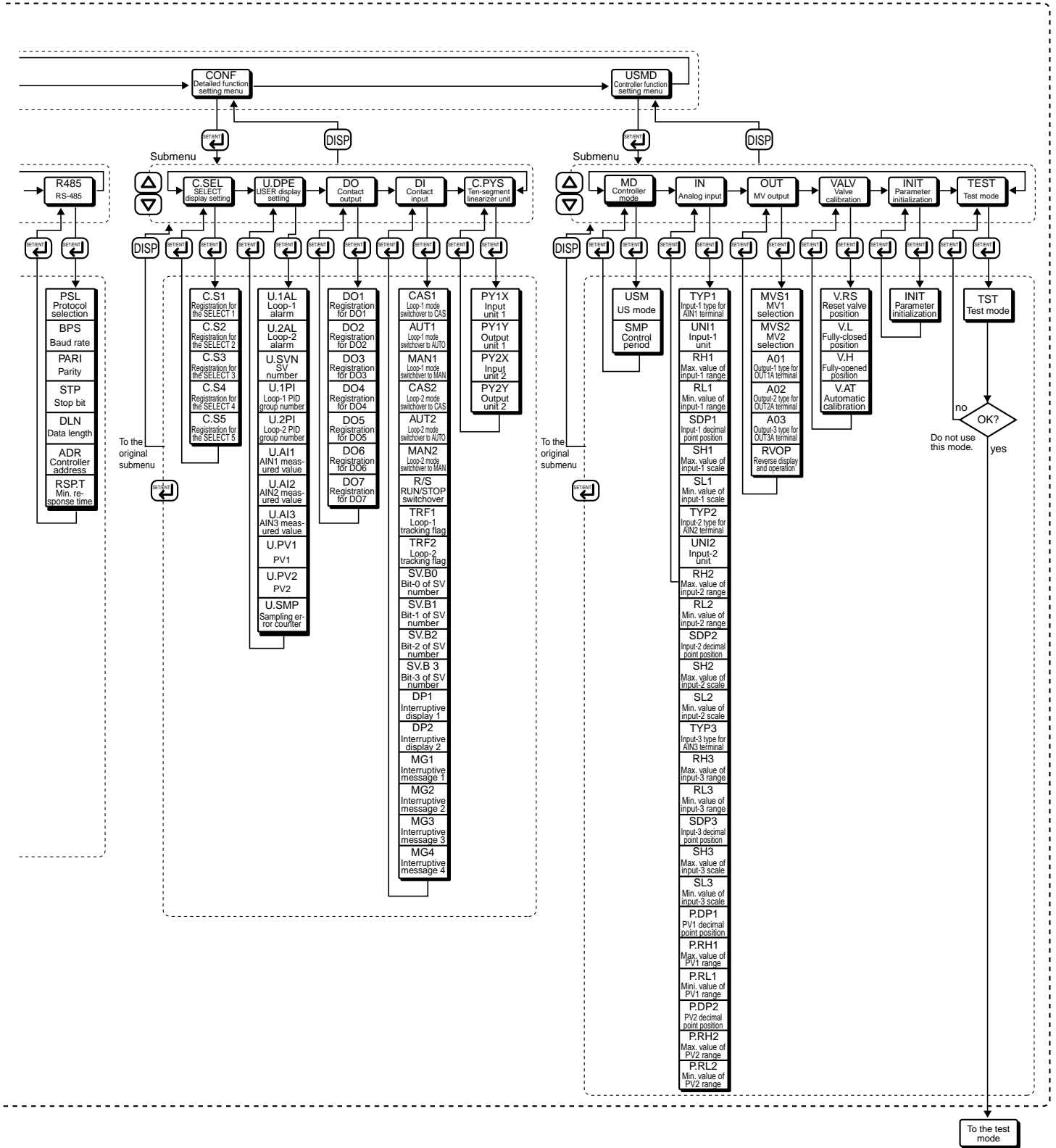

Blank Page

Appendix 6 Conditions of Use in Hazardous Areas

6.1 CSA standard

Before Model US1000 Digital Indicating Controller or any external equipment connected to it can be used in a hazardous area (as CSA standard non-incendive equipment), the field wiring parameters summarized in the following tables must be satisfied by all equipment either supplying energy to or receiving energy from the terminals of Model US1000 Digital Indicating Controller.

● Field Wiring Parameters

- Voc: Maximum open-circuit output voltage
- Isc: Maximum short-circuit output current
- Ca: Maximum allowable capacitance
- La: Maximum allowable inductance
- Vn: Normal circuit voltage
- In: Normal circuit current
- Cn: Maximum allowable capacitance based on the Vn normal circuit voltage
- Ln: Maximum allowable inductance based on the In normal circuit current
- Vmax: Maximum input voltage
- Imax: Maximum input current
- Ci: Maximum internal capacitance
- Li: Maximum internal inductance

■ Equipment Supplying Energy

Terminal Symbol (Signal Name)	Signal Type	Voc [V]	Isc [mA]	Ca [μ F]	La [mH]	Vn [V]	In [mA]	Cn [μ F]
OUT1A and OUT2A (manipulated outputs)	Current output	22.3	21	0.3	10	22.3	21	0.3
	Voltage pulse output	22.3	32.2	0.3	10	22.3	30	0.3
OUT3A (retransmission output)	Voltage output	5.25	10	1	50	5.25	2.7	1
LPS1 and LPS2 (transmitter's power supply)*1	Voltage output	27	35	0.2	2	27	24	0.2
AIN1 and AIN2 (analog inputs)	Resistance temperature detector input	1.23	0.13	1	50	1.23	0.13	1
FBIN (valve position feedback input)	Slide-resistor input	1.23	16	1	50	1.23	13	1
DI1 to DI7 (contact inputs)	Transistor contact	5	20	1	50	5	20	1
RS-485 (RS-485 communication)	–	4.4	86	1	1	4.4	40	1

*1: With a load resistance of at least 100 Ω

■ Equipment Receiving Energy

Terminal Symbol (Signal Name)	Signal Type	Vmax [V]	Imax [mA]	Ci [μ F]	Li [mH]
AIN1 and AIN2 (analog inputs)	Thermocouple input (mV DC)	10	6	0	0
	Standardized signal ("V DC" input)	20	6	0	0
AIN3 (analog input)	Standardized signal ("V DC" input)	20	6	0	0
DO4 to DO7 (contact outputs)	Transistor contact	30	200	0.1	0

- 1 Model US1000 Digital Indicating Controller for use in hazardous locations:
Non-incendive for Class I, Division 2, Groups A, B, C and D; or Class I, Zone 2, Group IIc
Provides Non-incendive Field wiring Connections for Class I, Division 2, Groups A, B, C and D or
Class I, Zone 2, Group IIc Hazardous Locations.
Temperature Code: T4
Ambient Temperature: 0 to 50°C
- 2 Wiring
 - * All wiring shall comply with Canadian Electrical Code Part I and Local Electrical Codes.
- 3 Operation
 - * WARNING - EXPLOSION HAZARD _ DO NOT DISCONNECT WHILE CIRCUIT IS LIVE
UNLESS AREA IS KNOWN TO BE NON-HAZARDOUS.
 - * AVERTISSEMENT _ RISQUE D'EXPLOSION. NE PAS DÉBRANCHER TANT LE QUE LE
CIRCUIT EST SOUS TENSION, À MOINS QU'IL NE S'AGISSE D'UN EMPLACEMENT
NON DANGEREUX.
- 4 Maintenance and Repair
The instrument modification or parts replacement by other than authorized representative of
Yokogawa Electric Corporation is prohibited and will void CSA Non-incendive Certification.
- 5 The suitability of the final installation is to be determined by the local authorities having jurisdic-
tion.

6.2 FM standard

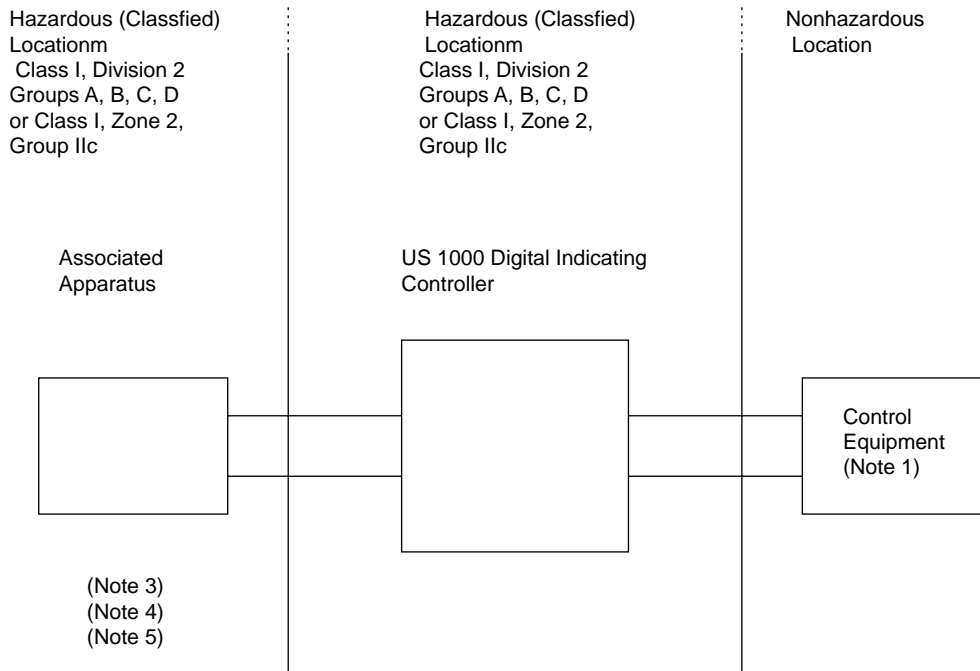

Nonincendive Field Wiring Parameters:

Output signal	Signal name	Voc [V]	Isc [mA]	Ca [μ F]	La [mH]
OUT1A	Current Output Voltage Pulse Output	22.3	32.2	0.3	10
OUT2A	Current Output Voltage Pulse Output	22.3	32.2	0.3	10
OUT3A	Voltage Output	5.25	10	1	50
Loop Power Supply for Transmitter (LPS1)	Power Supply	27	35	0.2	2
Loop Power Supply for Transmitter (LPS2)	Power Supply	27	35	0.2	2
Analog Input (AIN1)	RTD Input	1.23	0.13	1	50
Analog Input (AIN2)	RTD Input	1.23	0.13	1	50
Feedback Resistance Input		1.23	16	1	50
Contact Input (DI 1-7)		5	20	1	50
RS-485		4.4	86	1	1

The nonincendive field wiring concept allows interconnection of two FM Approved Nonincendive Apparatuses with nonincendive field wiring parameters not specifically examined in combination as a system when:
 $V_{oc} \leq V_{max}$, $I_{sc} \leq I_{max}$, $C_a \geq C_i + C_{cable}$, $L_a \geq L_i + L_{cable}$

Input signal	Signal name	Vmax [V]	Imax [mA]	Ci [μF]	Li [mH]
Analog Input (AIN1)	MV, TC input Voltage input	20	6	0	0
Analog Input (AIN2)	MV, TC input Voltage input	20	6	0	0
Analog Input (AIN3)	Voltage input	20	6	0	0
Contact Output (DO 1-7)	Transistor Output	30	200	0.1	0
<p>The nonincendive field wiring concept allows interconnection of two FM Approved Nonincendive Apparatuses with nonincendive field wiring parameters not specifically examined in combination as a system when: $V_{oc} \text{ or } V_t \leq V_{max}$, $I_{sc} \text{ or } I_t \leq I_{max}$, $C_a \geq C_i + C_{\text{cable}}$, $L_a \geq L_i + L_{\text{cable}}$</p>					

Notes:

- 1 Control equipment connected to the US 1000 Digital Indicating Controller must not use or generate more than 250Vrms or VDC.
- 2 Installation should be in accordance with the National Electrical Code (ANSI/NFPA 70).
- 3 The configuration of associated Apparatus must be FMRC Approval under Nonincendive Field Wiring Concept or be a simple apparatus (a device which can neither generate nor store more than 1.2V, 0.1A, 25mW, or 20 μ J, ex. Switches, thermocouples, LED's and RTD's).
- 4 Associated Apparatus manufacture's installation drawing must be followed when installing this equipment.
- 5 Associated Apparatus connection is representative of each input and output signal connection. Each signal shall be wired in a separate shielded cable.
- 6 No revision to drawing without prior FMRC Approval.
- 7 The suitability of the final installation is to be determined by the local authorities having jurisdiction.

Index

- ▽/△ 4-19
 </> 4-19
 1.A1 4-15
 1.A2 4-15
 1.A3 4-15
 1.A4 4-15
 1.D 4-15
 1.DR 4-17
 1.I 4-15
 1.P 4-15
 1.PMD 4-18
 1.SV 4-15
 1.X1 4-18
 1.Y1 4-18
 10-segment linearizer 4-18
- A**
- A 4-19
 A mode key lock 4-19
 A.BO1 4-18
 A.BO2 4-18
 A.BO3 4-18
 A.LC1 4-18
 A.LC2 4-18
 A.LC3 4-18
 A.SR1 4-18
 A.SR2 4-18
 A.SR3 4-18
 ADERR 8-5
 AIN1 3-3, 4-6
 AIN1 measured value 5-2
 AIN2 3-3, 4-6
 AIN2 measured value 5-2
 AIN3 3-3, 4-6
 AIN3 measured value 5-2
 AL1 4-13
 AL2 4-13
 AL3 4-13
 AL4 4-13
 Alarm functions 4-12
 Alarm output 3-6
 Alarm outputs 4-12
 Alarm setpoints 4-15
 Alarm statuses 5-5
 Alarm type 4-12
 Aluminum electric capacitor 8-1
 Analog input 4-6
 Analog input-1 type for AIN1 terminal 4-7
 Analog input-1 unit 4-7
 Approximation 4-18
 AT 6-14
 ATERR 6-14, 8-5
 AUTO mode 6-2, 6-12
 Auto-tuning 6-14
 Automatic operation 6-13
- B**
- B.OUT 8-5
 Backup function for the supervisory system. 4-4
 Biasing 4-18
- Block diagram 4-4
 Bracket 2-3, 8-1
 BS 4-17
 Burnout action 4-18
- C**
- C 4-19
 C mode key lock 4-19
 C.S1 5-6
 Cables 3-2
 Calibration of valve position 4-20
 CAS mode 6-2, 6-12
 CAS/AUTO/MAN mode selection 3-6
 Cascade type 6-1, 6-6
 Cascade Close 6-6
 Cascade control 3-6, 4-4
 Cascade control with two universal inputs 4-4
 Cascade input 4-6, 4-18
 Cascade open 6-7
 Cascade open and close 6-8
 Cascade primary-loop control 4-4
 Cascade secondary-loop control 4-4
 CMS 4-18
 COLD 4-19, 6-18
 Communication Functions 7-2
 Computation modules 7-3
 Contact input 3-6, 6-12, App. 1-3
 Contact output 3-6, App. 1-3
 Continuous PID computation 4-9
 Control computation 4-9
 Control output relay 3-3, 3-6, 8-2
 Control period 1-6
 Control relay 3-3, 4-9, App. 1-3
 Controller mode 4-4
 Controller type 6-1
 Cooling 4-9, 6-11
 CT1 4-19
 CT2 4-19
 Current output 4-9
 Custom Computation 7-3
 Custom computation control 4-4
 Cycle time of MV output 4-19
- D**
- D Register 7-4
 D-register Numbers 5-7
 Data setting key lock 4-19
 Derivative time 4-15, 6-16
 Direct/reverse action 4-17
 DNR 4-18
 Dual-loop type 6-1, 6-9
 Dual-loop control 4-4

E

EEPROM	8-1
Engineering units	1-6, App. 2-1
Environmental Conditions	App. 1-5
ERR	8-5
Errors	8-5
EU	App. 2-1
EUS	App. 2-1
External dimensions	2-2

F

Factory-set defaults	1-6
FBI	4-18
FBO	4-18
Feedback resistance input	App. 1-1
Feedforward input	4-6, 4-18
FFL	4-18
FGN	4-18
FL	4-17
Front Panel	1-2

H

Heating/cooling computation	4-9, 6-11
HOT	4-19, 6-18
Housing	2-1

I

I Relay	7-4
INIT	4-11
Input type	4-6, 4-7
Inputs	4-6
Integral time	4-15, 6-16
Isolation	App. 1-4

K

Key lock	4-20
----------------	------

L

Labels	1-7
LL1100 PC-based Parameters Setting Tool	7-3
LL1200 PC-Based Custom Computation Building Tool ..	7-3
Loop control for backup	4-4
Loop control with PV auto-selector	4-4
Loop control with PV auto-selector and two universal inputs	4-4
Loop control with PV switching	4-4
Loop control with PV switching and two universal inputs	4-4
Loop control with PV-hold function	4-4
Loop-1 alarm	5-2, 5-5
Loop-2 alarm	5-2, 5-5
Low signal cut-off	4-18
LP2 lamp	6-7, 6-9

M

M	4-19
M mode key lock	4-19
Main menu	4-2
MAN mode	6-2, 6-12
Manipulating MV	6-4
Manual operation	6-13

Manual Tuning	6-16
Maximum value of analog input-1 range	4-7
Measurement range	4-6
Menu lock	4-20
Minimum value of analog input-1 range	4-7
MODE	4-20
Model and Suffix Codes	ii
Mounting	2-3
MV lamp	6-4
MV operation key lock	4-19
MV1 selection	4-10
MV2 selection	4-10
MVS1	4-10
MVS2	4-10

N

Noise-prevention	3-2
NoMAP	5-6

O

O.LP1	4-20
O.LP2	4-20
O/C	6-8
On/off computation	4-9
On/off signal	4-19
OPEN/CLOSE switchover	3-6, 6-8
Operation displays	1-4, 5-1
Operation modes	6-2, 6-12
Operation parameters	4-1, 5-6, App. 3-1
Operations	6-1
Output type	4-9
OVER	8-5
Overshoots	4-18

P

Panel cutout dimensions	2-2
Parameter display	4-2
Parameter initialization	4-11
Parameters	4-1
Passive alarm	4-12
Password setting	4-19
PID	4-20
PID group	5-2
PID parameters	4-15, 4-19, 6-14, 6-16
Position proportional PID	4-9, 4-20
Power failure	6-18
Power recovery	4-19
Power supply	3-2, 3-4, App. 1-4
Power switch	1-5
PPID	4-19
Preset PID	4-19
Proportional band	4-15, 6-16
Pulse width of on/off signal	4-19
PV bias	4-17
PV filter	4-17
PV input	4-6
PV tracking	4-18
PV-hold and MAN mode	3-6
PV1	5-2
PV2	5-2
PVT	4-18
PWD	4-19
PYS1	4-20
PYS2	4-20

R

R.MD	4-19, 6-18
Range	4-6
Relay	3-3, 4-9, 8-1
Restart mode	6-18
RET1	4-19
Retransmission output	4-19, App. 1-3
RH1	4-7
RJC	8-5
RL1	4-7
RS-485 communication	4-18
RTD input wiring	3-2
RTH1	4-19
RTL1	4-19
RUN/STOP switchover	3-6, 6-17

S

Sampling error counter	5-2
SC	4-18
SELECT display	5-1, 5-6
Setup parameters	4-1, App. 4-1
Signals assigned to terminals	3-6
Single-loop type	6-1, 6-5
Single-loop control	4-4
SKIP	5-6
Square-root computation	4-18
Starting controller operation	6-13
Stepping response method	6-14
STOP	6-17
Stopping controller operation	6-17
Submenu	4-2
SUPER function	4-18
SV	6-3
SV digital display	6-3
SV number	4-19, 5-2
SV ramp-up/ramp-down rate	4-18
SV setting key lock	4-19
SVC	4-19
Switching the Operation Mode	6-2, 6-12

T

Tag Number	1-2, 1-7
Target Setpoint	4-15, 6-3
Temperature and humidity control	4-4, 6-9
Terminal assignment	3-1
Terminal cover	3-5
Terminal tightening torque	3-2
Terminals	3-2
Thermocouple wiring	3-2
Time proportional PID computation	4-19
Time proportional PID computation with relay output	4-9
Time proportional PID computation with voltage pulse	
output	4-9
Tracking input	4-6
Tracking switching	3-6
Transmitter	3-4
Troubleshooting	8-3
TYPI	4-7

U

U. 1AL	5-2
U. 1PI	5-2
U. 2AL	5-2
U. 2PI	5-2
U. AI1	5-2
U. AI2	5-2
U. AI3	5-2
U. PV1	5-2
U. PV2	5-2
U. SMP	5-2
U. SVN	5-2
UNI1	4-7
Universal inputs	4-6
UPR	4-18
USER displays	5-2
USM	4-5
US mode	4-4
USR	4-20

V

V.AT	4-20
V.H	4-20
V.L	4-20
V.RS	4-20
Valve position	4-20
Voltage input	4-6, App. 1-1
Voltage pulse output	4-9

W

Waiting action	4-12
Wire breakage	4-18
Wiring	3-1

Z

Zone PID	4-19
----------------	------

Blank Page

Revision Record

Manual Title : Model US1000 Digital Indicating Controller

Manual Number : IM 5D1A01-01E

Edition	Date	Details
First	Aug., 1998	Newly published
Second	Nov., 1998	Notice of CE mark certification, corrections to the hardware specifications, and change of style code to S2.
Third	Oct., 1999	Notice of FM standard certification.
Forth	Jun., 2004	Change of company name.

Written by Yokogawa Electric Corporation

Published by Yokogawa Electric Corporation
2-9-32 Nakacho, Musashino-shi, Tokyo 180-8750,
JAPAN

Blank Page

YOKOGAWA

Yokogawa Electric Corporation

YOKOGAWA ELECTRIC CORPORATION

Network Solutions Business Division

2-9-32, Nakacho, Musashino-shi, Tokyo, 180-8750 JAPAN

Phone: +81-422-52-7179 Facsimile: +81-422-52-6793

Sales Branch Offices

Tokyo, Nagoya, Osaka, Hiroshima, Fukuoka

YOKOGAWA CORPORATION OF AMERICA

Headquarters

2 Dart Road, Newnan, GA. 30265-1094 U.S.A.

Phone: +1-770-253-7000 Facsimile: +1-770-251-0928

Sales Branch Offices / Texas, Chicago, Detroit, San Jose

YOKOGAWA EUROPE B. V.

Headquarters

Databankweg 20, 3821 AL Amersfoort THE NETHERLANDS

Phone: +31-334-64-1611 Facsimile: +31-334-64-1610

Sales Branch Offices / Houten (The Netherlands), Wien (Austria), Zaventem

(Belgium), Ratingen (Germany), Madrid (Spain), Bratislava (Slovakia), Runcorn (United Kingdom), Milano (Italy), Vélizy Villacoublay (France), Johannesburg (Republic of South Africa)

YOKOGAWA AMERICA DO SUL S.A.

Headquarters & Plant

Praca Acapulco, 31-Santo Amaro, Sao Paulo/SP, BRAZIL CEP-04675-190

Phone: +55-11-5681-2400 Facsimile: +55-11-5681-4434

YOKOGAWA ENGINEERING ASIA PTE. LTD.

Head office

5 Bedok South Road, Singapore 469270 SINGAPORE

Phone: +65-6241-9933 Facsimile: +65-6241-2606

YOKOGAWA ELECTRIC KOREA CO., LTD.

Seoul Sales office

395-70, Shindaebang-dong, Dongjak-gu, Seoul, 156-010, KOREA

Phone: +82-2-3284-3000 Facsimile: +82-2-3284-3019

YOKOGAWA TAIWAN CORPORATION

Head office

17F, No.39, Sec. 1, Chung Hwa Road Taipei, 100 TAIWAN

Phone: +886-2-2314-9166 Facsimile: +886-2-2314-9918

YOKOGAWA AUSTRALIA PTY. LTD.

Head office

Centre Court D1, 25-27 Paul Street North, North Ryde, N. S. W. 2113, AUSTRALIA

Phone: +61-2-9805-0699 Facsimile: +61-2-9888-1844

YOKOGAWA INDIA LTD.

Head office

40/4 Lavelle Road, Bangalore, 560 001, INDIA

Phone: +91-80-227-1513 Facsimile: +91-80-227-4270

LTD. YOKOGAWA ELECTRIC

Grokholskiy per. 13, Build. 2, 4th Floor, 129010, Moscow, RUSSIA FEDERATION

Phone: +7-095-737-7868 Facsimile: +7-095-737-7869
